



BID DOCUMENTS  
SOUTH RAILWAY ST DITCHING

CONTRACT 4-2023  
MARCH 2023

**City of Morden**  
**Engineering and Planning**  
Office: 133 7<sup>th</sup> Street, MB  
Mailing: 100-195 Stephen Street,  
Morden, MB,

SOUTH RAILWAY ST DITCHING  
CONTRACT 4-2023  
INDEX

---

SECTION 1: Invitation to submit Bids

SECTION 2: Instructions to bidders

SECTION 3: Agreement

SECTION 4: Bid Form

SECTION 5: General Conditions

SECTION 6: Supplementary conditions

SECTION 7: Specifications

SECTION 8: Drawings

SOUTH RAILWAY ST DITCHING  
CONTRACT 4-2023  
**SECTION 1. INVITATION TO SUBMIT BIDS**

---

- 1. PROJECT DESCRIPTION .....2
- 2. PROJECT LOCATION .....2
- 3. DELIVERY AND OPENING OF BIDS .....2
- 4. ENQUIRIES AND ADDENDA.....3

## BID DOCUMENTS

**1. PROJECT DESCRIPTION**

- 1.1. The Work to be done under this Contract involves ditching, rip-rap, top soil, seeding and erosion protection in accordance with the Contract Documents.

**2. PROJECT LOCATION**

- 2.1. The area of work is the ditch on the north side of South Railway St from Mountain St to 9<sup>th</sup> St South in Morden.

**3. DELIVERY AND OPENING OF BIDS**

- 3.1. The date and time of Bid Closing are 3p.m. local time on **April 20<sup>th</sup>, 2023**. The City will receive bids at the City Office:

100-195 Stephen Street  
Morden, MB  
R6M 1V3

- 3.2. The submission must be contained in a sealed envelope or package labeled as follows:

City of Morden  
SOUTH RAILWAY ST DITCHING  
Bidder's Name/Entity  
Bidder's Contact Information

- 3.3. Bid package must include:

- Bid Form (Section 4);
- Signed Agreement (Section 3);
- Bid security as per Section 2.10 (Instructions to Bidders);
- All requested specifications.

- 3.4. The City reserves the right to reject incomplete Bids.

- 3.5. Bids submitted after the above time will be returned to the Bidder unopened.

- 3.6. Bids will be opened in public on April 20<sup>th</sup>, 2023 at 3:30p.m. at the following address:

Civic Center Boardroom  
100-195 Stephen Street  
Morden, MB

The bid results will be posted on the City's website.

- 3.7. The City will not accept electronic submission.

- 3.8. The City will not consider oral submissions, or any other form of submission not identified herein, for acceptance.

- 3.9. The City will accept amendments to a Bid submission providing that such amendment is submitted as prescribed herein, signed by the person(s) who signed the original submission, and

## | BID DOCUMENTS

that it arrives prior to Bid Closing in a sealed envelope labeled with the details described above. Such amendments must be in accordance with the Bid Documents.

- 3.10. Bids will be analyzed by the City after which any part or all parts of the Contract may or may not be awarded, to one or more Bidders subject to the discretion of the City.
- 3.11. The City reserves the right to accept or reject any or all offers, and to request any clarifications necessary to adjudicate the submissions.
- 3.12. Bidder may withdraw an unopened bid submissions until Bid Closing either in person or by phone. After Bid Closing, Bids may not be withdrawn.
- 3.13. Upon opening Bid Submissions, the City may announce the Total Bid price for submissions at the City's discretion but will not announce or disclose unit prices in any way.

**4. ENQUIRIES AND ADDENDA**

- 4.1. For any enquiries relating to the Bid please contact:  
Tatiana Sinchenko  
Engineering Assistant  
204-822-4434 ext.1105  
[tsinchenko@mymorden.ca](mailto:tsinchenko@mymorden.ca)

OR

Santokh Singh Randhawa, M. Eng., P. Eng.  
Deputy City Manager  
Phone:(204) 822-2567  
[srandhawa@mymorden.ca](mailto:srandhawa@mymorden.ca)

- 4.2. Clarifications, interpretations, and explanations may be made in the form of Addenda. The City may issue addenda during the Bid period and will distribute such Addenda to all persons known by the City to have obtained a set of the Bid Documents. All such Addenda shall become part of the Bid Documents. The City encourages you to register your interest by providing email and contact information.
- 4.3. No oral clarifications, interpretations, or explanations by any person whatsoever shall bind the City in the interpretation of the Bid Documents.
- 4.4. The City will consider any requests for extension to Bid Closing but reserves the right to do so at its own discretion.

END OF SECTION

---

SOUTH RAILWAY ST DITCHING  
 CONTRACT 4-2023  
 SECTION 2. INSTRUCTIONS TO BIDDERS

1.	BID DOCUMENTS AND SUBMISSION OF BIDS.....	2
2.	SITE MEETING .....	2
3.	OMISSIONS OR DISCREPANCIES .....	2
4.	BID MODIFICATION .....	3
5.	BID WITHDRAWAL .....	3
6.	LUMP SUM FOR OTHER REQUIREMENTS .....	3
7.	CURRENCY .....	4
8.	AGREEMENT BETWEEN THE CITY AND THE BIDDER.....	4
9.	INFORMATION REQUESTS .....	4
10.	BID SECURITY .....	4
11.	PERFORMANCE BOND .....	4
12.	HOLDBACK .....	4
13.	SPECIFIC RETENTION.....	4
14.	ALTERNATE PRICES .....	5
15.	GOODS AND SERVICE TAX .....	5
16.	MANITOBA RETAIL SALES TAX .....	5
17.	COMMENCEMENT OF THE WORK .....	5
18.	COMPLETION DATE.....	5
19.	MATERIAL AND EQUIPMENT SUPPLIERS .....	5
20.	SUBCONTRACTORS .....	5
21.	ACCEPTANCE AND EVALUATION OF BIDS.....	6
22.	SUBDIVISION OF WORK .....	6
23.	SITE CONDITIONS AND INFORMATION DOCUMENTS .....	7
24.	HEALTH AND SAFETY .....	7
25.	BIDDING ON ALTERNATIVES .....	8
26.	SOIL INFORMATION .....	9
27.	WAIVER.....	9
	NOTE:.....	5

**1. BID DOCUMENTS AND SUBMISSION OF BIDS**

1.1 Bid Documents shall be available as follows:

- 100-195 Stephen St, Morden, MB;
- City website;
- By contacting as indicated in Section 1.

1.2 Bid shall be made on the Bid Form provided and shall be submitted in a sealed envelope clearly marked as indicated in **Section 1**.

1.3 The Bid Documents shall consist of the following:

- Instructions to Bidders;
- Bid Form;
- Addenda (if any);
- Agreement;
- Definitions;
- General Conditions
- Supplementary Conditions;
- Standard Specifications;
- Drawings as listed;
- Schedules (if any)

1.4 All requirements that use word “shall” or “must” are mandatory and the Bidder’s Bid must substantially comply or fulfill such requirements, or it shall be as non-compliant; all requirements that use the term “should” are desired and the Bidder’s response to such requirements shall be considered in analyzing the Bid.

1.5 The City shall not be responsible for lost or misplaced Bids, or amendments to Bids, if the Bidder hasn’t placed it at the City Office.

1.6 All Bids should be signed and sealed in the case of a corporation and in the case of an individual, partnership or non-incorporated organization should be signed and witnessed.

**2. SITE MEETING**

Site meeting may be arranged upon request.

**3. OMISSIONS OR DISCREPANCIES**

Should the Bidder find discrepancies in, or omissions from, the Bid Documents, or be in doubt as to their meaning, it should at once notify the City, who may send an Addendum to all Bidders.

No oral interpretation made by the City to any Bidder as to the meaning of any part of the Bid Documents shall be binding upon the City, or be effective to modify any of the provisions of the Bid Documents. Words and abbreviations used in the Bid Documents which have well known technical

or trade meanings, or are defined in the Bid Documents, shall be interpreted in accordance with such meanings or definitions. Every request for an interpretation shall be made in writing and promptly directed to the City's representative.

#### **4. BID MODIFICATION**

- 4.1 A Bid submitted in accordance with these Instructions to Bidders may be modified provided the modification:
  - 4.1.1 is in the form of a letter and all pages of such letter are received at the address specified in Clause 1 prior to the Bid Closing Time;
  - 4.1.2 states the name of the Bidder and the nature of the modification; and
  - 4.1.3 is signed by the Bidder's authorized representative.
- 4.2 Where a modification is directing a change in the Bid Price, the modification shall not reveal the original Bid Price nor the revised Bid Price:
  - 4.2.1 on lump sum Bids, only the amount to be added to or deducted from the original Bid Price shall be stated;
  - 4.2.2 when unit prices are used, only the amount to be added to or deducted from each original unit price shall be stated;
  - 4.2.3 the City shall not accept responsibility for the content of modifications or modifications that are, for any reason, delayed, illegible or otherwise improperly received. The City may, in its discretion, disregard modifications that are improperly received.

#### **5. BID WITHDRAWAL**

- 5.1 Any Bidder may withdraw its Bid either personally or by written request prior to the Bid Closing Time.
- 5.2 The withdrawal of a Bid shall not prejudice the right of such Bidder to submit a new Bid. If a Bid is withdrawn after the Bid Closing Time, the accompanying Bid Security (where required) is subject to forfeiture in like manner as in the failure to execute an Agreement after award as provided herein.

#### **6. LUMP SUM FOR OTHER REQUIREMENTS**

- 6.1 Under this item of the Bid Price Form, the Bidder shall enter his bid price for providing items such as watchmen, permits and approvals (other than those to be paid by the City), items required by the Drawings or Specifications but which have been omitted from the Schedule and other items required by the Contract but not specifically covered by or related to the other items in the Schedule.
- 6.2 Each Progress Payment Certificate will include a percentage of the contract price for this item in proportion to the percentage of the permanent works completed. The submission by a Bidder of an unbalanced price for this item renders the Bid liable to disqualification.



## 7. CURRENCY

All dollar amounts stated in the Bid Documents are in Canadian dollars unless otherwise indicated. The City reserves the right to reject conditional prices, or prices subject to rise and fall for any reason.

## 8. AGREEMENT BETWEEN THE CITY AND THE BIDDER

- 8.1 The Bidder agrees that the City's sole obligation is to give consideration to the Bid in accordance with the Bid Documents. In return, the Bidder has prepared and submitted its Bid, and agrees:
- 8.1.1 to enter into a contract in the form provided in Section 2 with the City in accordance with the Bid Documents, if the City issues a notice of acceptance, within sixty (60) days of the Bid Closing Time (or such longer period as is agreed between the parties) (the "Bid Period"); and
  - 8.1.2 that the Bid is irrevocable, valid and shall remain open for acceptance for the Bid Period.

## 9. INFORMATION REQUESTS

The Bidder shall comply with any reasonable requests for information made by the City, including information about the Bidder and its Subcontractors and Suppliers.

## 10. BID SECURITY

***Bid security in the form of a bid bond or certified cheque, irrevocable letter of credit in the name of City of Morden for an amount of 10% of the bid price is required to be submitted with the bid. The bid security will be released to unsuccessful bidders once the City enters into an agreement with the successful bidder. The bid security will be released to successful bidder at the time of the first progress payment, once the holdback amount is more than 10% of the contract price.***

## 11. PERFORMANCE BOND

The City will not require a performance bond for this project.

## 12. HOLDBACK

The City will deduct 7.5% from payments to be made under this contract and retain this amount for a period of 40 days after the date of issuance of Certificate of Substantial Completion.

## 13. SPECIFIC RETENTION

The City reserves the right to retain the funds specifically for the correction or completion of deficient work or incomplete elements of the project (separate and apart from the holdback). The amount of Specific Retention will be determined based on the Substantial Completion inspection and indicated in Certificate of Substantial Completion. Specific retention amounts will be released as incomplete or deficient work is corrected to meet City's acceptance.

**14. ALTERNATE PRICES**

Where called for, the Bidder must submit prices for all alternates shown in the places provided in the Bid Form.

**15. GOODS AND SERVICE TAX**

It shall be assumed, unless otherwise stated, that the Bid Price does not include federal Goods and Services Tax (GST). The appropriate GST levy shall be paid to the successful Bidder in addition to the amount approved by the City for Work performed under the Contract and, therefore, shall not affect the Bid Price.

**16. MANITOBA RETAIL SALES TAX**

The Bid Price will include all Applicable Retail Sales Tax. The Bidder shall include Retail Sales Tax in the prices that they may be required to pay on materials and equipment to be utilized or expended in the construction of the works.

The City will not consider any claim by the Contractor or any subcontractor for reimbursement of Retail Sales Tax paid.

**17. COMMENCEMENT OF THE WORK**

The Commencement Date of the Work shall be **as soon as conditions allow**. Bidders are to indicate availability for the commencement of the work in Section 4. The City may negotiate with the successful Bidder(s) or use proposed dates in evaluating Bid Submissions.

**18. COMPLETION DATE**

The work must be completed **before June 30<sup>th</sup>, 2023**, weather permitted.

**19. MATERIAL AND EQUIPMENT SUPPLIERS**

- 19.1 The Contractor must provide all materials required for the completion of the works unless otherwise indicated in the Bid Documents. The details for all materials are shown on the plans and in Clause 19 of Section 4.
- 19.2 The Bidder must state, if requested in the Bid Form, the names of the material and equipment Suppliers it intends to use for the Work together with the trade or brand names of the material and equipment to be supplied.
- 19.3 The Contractor shall be responsible for the provision of all the equipment, plant, tools, and labour required to complete the works to the fulfillment of the terms of the Contract Documents. The cost for this shall be deemed to be included in the Contract Price.

**20. SUBCONTRACTORS**

The Bidder must state, as requested in the Bid Form, the names of the Subcontractors and Suppliers it intends to use on the Work and the portion of the Work on which each Subcontractor is intended to be used.

**21. ACCEPTANCE AND EVALUATION OF BIDS**

- 21.1 The City, at its own discretion, reserves the right to:
- Accept any Bid;
  - Reject any Bid;
  - Accept a Bid which is not the lowest Bid;
  - Reject a Bid even if it is the only Bid received by the City;
  - Accept all or any part of a Bid.
- 21.2 The City reserves the right to request clarifying information of any form, at the City's discretion, to facilitate the adjudication of bids. Failure to provide requested information will factor into the City's adjudication process.
- 21.3 The City reserves the right to reject any Bid containing errors, omissions, erasures, items not part of the Bid form, or any obviously unbalanced Bid.
- 21.4 The City may disqualify or reject Bids containing non-qualifying conditions or otherwise failing to comply with the Bid Documents. The City reserves its right to reject or retain for its consideration non-qualifying Bid submissions.
- 21.5 The City requires a Bidder to submit qualifications and experience to prove that the Bidder is capable of completing the Works in Section 4. Bid Form.
- 21.6 The City may choose to disqualify any Bidder who it deems as inexperienced, or for any other reason may not be capable of completing the works. The City may require a Bidder to provide security in addition to that specified herein at the City's discretion before approving the award of Contract to a Bidder.
- 21.7 The City will notify the successful Bidder or Bidders in writing that its Bid has been accepted.
- 21.8 The City may consider the following criteria to determine the successful bidder:
- the qualifications of the Bidder;
  - Bid Prices;
  - Completion Time;
  - the City's relationship and experience with any Bidder;
  - the use of equivalents/alternates;
  - the quality and responsiveness of the Bid, including, without limitation, all requested information;
  - quality of previous work done for the City;
  - quality of previous work done by subcontractors.
- 21.9 The City may reject any subcontractors on the same basis as the criteria listed in 1.7. The City may permit a Bidder to procure a different subcontractor, but such a change would not be considered as affecting the Bid submission in any other way.

**22. SUBDIVISION OF WORK**

- 22.1 Subject to the rights of the City and according to the Contract Documents the Contractor shall be solely responsible for and shall supervise and direct the works. The Contractor shall determine the means, methods, techniques, sequences, and procedures of construction, except where the

Contract Documents, in order to define the quality of a particular item of work, specify a means, method, technique, sequence, or procedure for construction of that item of the work.

- 22.2 The successful Bidder shall be responsible for the administration of the Work and the subdivision of the Work to Subcontractors. All disputes as to the scope of the Work to be carried out by Subcontractors shall be resolved by the successful Bidder so that all Work is carried out in accordance with the Bid Documents. No claims for extras shall be allowed on the basis that Subcontractors did not include the same in their scope of Work due to any subdivisions of Work expressed or implied in the Bid Documents.
- 22.3 Where there is overlap between Contractors, the City will coordinate schedules, testing and all matters related to the interactions between overlapping Works.

### **23. SITE CONDITIONS AND INFORMATION DOCUMENTS**

- 23.1 The Information Documents are furnished merely for the general reference and convenience of each Bidder and do not form part of the Bid Documents. The Information Documents are not in any way represented, warranted or guaranteed to be accurate or complete by the City. Each Bidder acknowledges and agrees that the City does not owe any duty of care to it concerning the accuracy or completeness of the Information Documents.
- 23.2 The Bidder is responsible for examining the work site before submitting a Bid. The Bidder is responsible for familiarizing itself with and allowing for all site conditions including the project locations, local conditions, access locations and limitations, topographical conditions, presence of obstructions, working widths, and all other site conditions which may affect the Work.
- 23.3 The Bid is deemed to include the cost of working in these conditions and the City will not consider additional payment or time extensions due to site conditions which were or would have been reasonably foreseeable given a proper inspection of the site by the Bidder.
- 23.4 Should a Bidder wish to make exploratory excavations or investigations at the site, it shall make arrangements with the City. The City, at its own discretion, may set conditions or limitations on such excavations or investigations and may refuse to permit them.

### **24. HEALTH AND SAFETY**

- 24.1 The Contractor shall be deemed to be a “prime contractor” under the Regulations of the Workplace Safety and Health Act.
- 24.2 The Contractor is responsible for ensuring that all activities under its control, for the duration of the works, are conducted in compliance with the Province of Manitoba’s Workplace Safety and Health Act including all relevant Regulations.
- 24.3 The Contractor alone shall always be responsible for the safety of its employees, its subcontractors’ employees and other persons and equipment lawfully on the work site. The Contractor shall be responsible for maintaining the Work Site as a safe place to work and perform the work in a manner which meets all applicable requirements and standards for the Work Site.

- 24.4 The Contractor shall obtain and maintain Workers Compensation Insurance as required by the Workers Compensation Act. The Contractor shall be registered and be in good standing with the Workers Compensation Board. The Contractor acknowledges that the City may query the Contractor’s standing with the Workers Compensation Board at the City’s discretion, and the City reserves the right to reject a Bid submission on the basis of the Contractor’s standing with the Workers Compensation Board.
- 24.5 The Contractor shall provide a copy of their comprehensive general liability insurance subject to limits of not less than two million dollars (\$2,000,000) with City of Morden and its officers named as insured under this policy. General liability insurance shall remain in effect continuously until the Construction Completion Certificate has been issued.
- 24.6 The Contractor will, at all times during the construction process, take every precaution to ensure the safety of vehicular, bicycle, and pedestrian traffic, and of any other contractor, sub-contractor, visitor, inspector, or any party on site for any reason, both during and outside of normal working hours.

**25. BIDDING ON ALTERNATIVES**

- 25.1 Products and methods used and/or specified in these bid documents are intended to establish a standard of quality and are not meant to exclude alternative products or methods.
- 25.2 When a request to substitute an allegedly equal material or equipment is made to the City, the City may approve the substitution either as an equal or an alternate. If an item is approved as an equal, the Bidder may use that item in place of the specified item. If the item is approved as an alternate, the Bidder shall base its Bid Price upon the specified item and shall indicate in its Bid the reduction in price which shall apply if use of the alternate item is allowed.
- 25.3 Bidders shall include in their bid prices for any changes required in design or in the work of other trades to accommodate such alternatives. Any later claims for an addition to the Contract Price because of changes in design or in the work required by incorporating the alternatives into the work will be rejected.
- 25.4 Alternatives that are ambiguous or do not contain sufficient information to allow the City to properly evaluate the products of execution proposed may be rejected. Bidders may list such Alternatives in the bid form and shall provide an Alternative Price should the Alternative be accepted. Acceptance of any Alternative is at the sole discretion of the City.
- 25.5 The City shall consider alternatives, provided that:
  - 25.5.1 The Alternatives are priced clearly and separately from the base Bid (Use Bidder’s Proposed Alternatives in Bid Form);
  - 25.5.2 Clearly identifying the specified product or method of execution, and the proposed alternative product or method of execution;

25.5.3 Submitted sufficient information to enable the City to properly evaluate the alternative proposal. Such information to include specifications, product literature, samples, photographs, and other pertinent data to completely describe products or execution proposed, including optional features, finishes, materials and sizes.

25.6 To facilitate evaluation of alternates the City reserves the right to:

- Request additional information;
- Extend the time to review.

## **26. SOIL INFORMATION**

Soil information provided in the documents and/or drawings cannot reveal all conditions that exist or can occur on the site. Bidders are responsible for assuring themselves of actual site conditions.

## **27. WAIVER**

The Bidder hereby waives any claim for damages or costs of any nature against the City (including, without limitation, the cost of preparing and submitting the Bid, and any anticipated profits and contributions to overhead) arising out of the City's use of its discretion under the Bid Documents. In preparing and submitting this Bid, Bidders are advised that the City may award other contracts for work in the area.

END OF SECTION

---

SOUTH RAILWAY ST DITCHING  
CONTRACT 4-2023  
**SECTION 3. AGREEMENT**

---

1. AGREEMENT.....	2
2. CONTRACT DOCUMENTS .....	2
3. CONTRACT PRICE .....	2
4. PAYMENT .....	2
5. TIME .....	3
6. CONTRACTOR’S COVENANTS .....	3
7. CONTRACTOR’S REPRESENTATIONS .....	4
8. RIGHTS AND REMEDIES.....	4

**1. AGREEMENT**

THIS Agreement made as of this \_\_\_\_\_ day of \_\_\_\_\_, 20\_\_\_\_, by and between City of Morden of the first part and \_\_\_\_\_ of the City of \_\_\_\_\_ in the Province of \_\_\_\_\_ (hereinafter called "the Contractor") of the second part.

The City of Morden and the Contractor agree as follows:

- 1.1 This agreement will come into force from the date of last signature on the agreement and remain in force until completion of the work unless terminated in accordance with GC19.
- 1.2 Contract means this written agreement and the contract documents listed in Section 2.0 of this written agreement and subsequent amendments made in accordance with the provisions of the contract documents.
- 1.3 The Contractor shall perform The Work required by the Contract for:

**SOUTH RAILWAY ST DITCHING**

in strict accordance with the Plans and Specifications and to deliver the Work, complete and fully finished in every particular to the City of Morden.

**2. CONTRACT DOCUMENTS**

The following documents, together with this Agreement, shall constitute the Contract Documents referred to in article 1.2 — THE WORK:

- A. Instructions to Bidders
- B. Bid Form
- C. Addenda (if any)
- D. Notice of Acceptance
- E. Definitions
- F. Supplementary Conditions
- G. Drawings and Specifications, as listed in the Bid Documents

**3. CONTRACT PRICE**

The Contract Price shall be as follows:

- 3.1 The Bid Amount, as set out in the Bid Form (Section 4), for the unit prices agreed upon and for the actual quantities of work performed by the Contractor; and
- 3.2 Any changes made to contract price on account of scope changes, as may be required, in accordance with GC7.

**4. PAYMENT**

The City of Morden shall make payments in Canadian funds to the Contractor for the actual Work completed including materials in place at the unit prices stated in the Contractor’s Tender Forms



and in accordance with the payment conditions and other applicable provisions of the Contract.

- 4.1 Measurements and payments will be according to the unit prices and units indicated in Section 4, Bid Form, and as explained or qualified herein.
- 4.2 Payment will be monthly unless the City and Contractor make other arrangements and the City will deduct the appropriate holdback from each progress payment.
- 4.3 Provided that the City may withhold or, on account of subsequently discovered evidence, nullify the whole or part of any Certificate of Completion to such an extent as may be necessary to protect the City from loss on account of:
  - A. The Contractor’s unsatisfactory execution of the Work.
  - B. Defective or damaged Work requiring correction or replacement.
  - C. Claims or liens filed or reasonable evidence indicating the probable filing of claims or liens.
  - D. Failure of the Contractor to make payments promptly to subcontractors or for materials or labour.
  - E. A reasonable doubt that the Contract can be completed for balance unpaid.
  - F. Damage to another Contractor’s Work which has not been settled which may result in the Other Contractor whose Work has been damaged bringing action against the City; in case of such action, the Contractor shall bear the expense of same.

When the above grounds are satisfactorily accounted for, payment shall be made for the amounts withheld because of them.

## 5. TIME

Time shall be of the essence of this Agreement. The Contractor shall commence the Work on the date agreed upon by both parties and shall complete all works on or before the completion date specified in *SECTION 2. Instructions to the Bidders*.

## 6. CONTRACTOR’S COVENANTS

Contractor undertakes and agrees:

- 6.1 To perform & fulfill every agreement contained in the Contract Documents and to furnish all labour, materials and equipment unless otherwise indicated, together with all work incidental thereto, necessary and required to perform all the Work described in the Contract Documents and which have been executed in duplicate by both parties and which were prepared by the City.
- 6.2 To complete the Work by dates stated in *SECTION 2. Instructions to the Bidders*.
- 6.3 In the event of the Contract being extended to include additional Work, the additional work will be subject to the same terms and conditions as this Contract.
- 6.4 To maintain the Work in complete repair until the date of the Final Acceptance Certificate.
- 6.5 Should the Contractor fail to complete the Work in accordance with the Contract and to the satisfaction of the City within the time specified, the Contractor shall pay to the City amounts payable specified as liquidated damages that the City will suffer due to said delay and default. The

City reserves the right to recover any other kind of damages or losses which were not known or calculable when the liquidated damages were determined. The City may deduct and retain the amounts of such liquidated damages out of the monies, which may be due or become due to the Contractor under the Contract.

- 6.6 Notwithstanding the issue of certificates under Mechanics' or Builder's Lien legislation enabling the Contractor to obtain a reduction in the lien holdback, and notwithstanding the wording of such certificates, the Contractor shall protect the work of the subcontractor(s) pending completion of the entire Work and shall correct any defects in it regardless of whether the same were apparent when such certificates were issued.

## **7. CONTRACTOR'S REPRESENTATIONS**

In order to induce the City to enter into this Agreement the Contractor makes the following representations:

- 7.1 The Contractor is skilled in the construction of the Work described in the Contract Documents and is well able to perform the Work in accordance therewith.
- 7.2 The Contractor has examined the site of the Work and has familiarized himself with the nature and extent of the Contract Documents, Work, locality, and with all local conditions and federal, provincial and local laws, ordinances, rules and regulations that in any manner affect cost, progress or performance of the Work.
- 7.3 The Contractor has studied carefully all reports of investigations and tests of subsurface and latent physical conditions at the site or otherwise affecting cost, progress or performance of the Work which have been identified in the Contract Documents and acknowledges that the reports and tests are not guaranteed as to accuracy or completeness, nor are they part of the Contract Documents. The Contractor does not rely upon any information given verbally or statement made to him in relation to the Work by the City.
- 7.4 The Contractor has made or caused to be made examination, investigations, and tests and has carefully studied reports and related data based thereon or obtained therefrom, as he deems necessary for the performance of the Work at the Contract Price, within the Contract Time and in accordance with the other terms and conditions of the Contract Documents; and no additional examinations, investigations, tests, reports or similar data are or will be required by the Contractor for such purpose.
- 7.5 The Contractor has correlated the results of all such observations, examinations, investigations, tests, reports and data with the terms and conditions of the Contract Documents.
- 7.6 The Contractor has given the City written notice of all conflicts, errors or discrepancies that he has discovered in the Contract Documents and the written resolution thereof by the City is acceptable to the Contractor or, no written notice having been given, the Contractor takes no exception to the Contract Documents as written.

## **8. RIGHTS AND REMEDIES**

- 8.1 The duties and obligations imposed by the Contract Documents and the rights and remedies available thereunder shall be in addition to and not a limitation of any duties, obligations, rights and remedies otherwise imposed or available by law.

8.2 No action or failure to act by the City or Contractor shall constitute a waiver of any right or duty afforded any of them under the Contract, nor shall any such action or failure to act constitute an approval of or acquiescence in any breach thereunder, except as may be specifically agreed in writing.

8.3 The Contract shall be interpreted under and governed by the laws of Province of Manitoba and Canada.

IN WITNESS WHEREOF the Contractor and the City have executed this Agreement this \_\_\_\_ day of \_\_\_\_\_, 2023.

SIGNED, SEALED and DELIVERED  
on behalf of the Contractor

CONTRACTOR

In the presence of:

\_\_\_\_\_  
Company Name

\_\_\_\_\_  
Print Name of Witness

\_\_\_\_\_  
Signature

\_\_\_\_\_  
Address

\_\_\_\_\_  
Print Name & Title

\_\_\_\_\_  
Signature of Witness

\_\_\_\_\_  
Signature

\_\_\_\_\_  
Print Name & Title

SIGNED, SEALED and DELIVERED  
on behalf of the City

**CITY OF MORDEN**

In the presence of:

\_\_\_\_\_  
Company Name

\_\_\_\_\_  
Print Name of Witness

\_\_\_\_\_  
Signature

\_\_\_\_\_  
Address

\_\_\_\_\_  
Print Name & Title

\_\_\_\_\_  
Signature of Witness

\_\_\_\_\_  
Signature

\_\_\_\_\_  
Print Name & Title

SOUTH RAILWAY ST DITCHING  
CONTRACT 4-2023  
**SECTION 4. BID FORM**

---

1. SUBMISSION .....	2
2. TENDER PRICE.....	2
3. OBLIGATIONS .....	3
4. ENCLOSURES .....	3
5. DECLARATIONS.....	3
6. AGREEMENTS .....	4
7. SIGNATURES .....	4
8. SCHEDULE OF UNIT PRICES .....	6
9. SCHEDULE OF EQUIPMENT, LABOUR, MATERIALS AND ASSOCIATED RATES.....	7
10. SCHEDULE OF SUBCONTRACTORS.....	8
11. SCHEDULE OF QUALIFICATIONS .....	9
12. BIDDER’S PROPOSED ALTERNATIVES .....	10
13. TRAFFIC MANAGEMENT PLAN .....	11
14. TREE PROTECTION PLAN AGREEMENT.....	12

**BID FORM**

**1. SUBMISSION**

1.1 The following tender is hereby submitted to:

City of Morden  
 hereinafter called the "Owner"

1.2 On behalf of:

\_\_\_\_\_  
 Legal Name of Tenderer

\_\_\_\_\_  
 Address

\_\_\_\_\_  
 City Province Postal Code

\_\_\_\_\_  
 Phone Fax Contact Person

Hereinafter called the "Tenderer".

1.3 The Tenderer agrees to furnish all material, labour, plant and equipment necessary for the proper construction of the:

**CITY OF MORDEN  
 SOUTH RAILWAY ST DITCHING**

in accordance with the Agreement, General Conditions, Supplementary Conditions, Specifications, Addenda (if any) and Drawings which will form the Contract Documents.

**2. TENDER PRICE**

2.1 I/We, the Tenderer, having carefully reviewed the Tender Documents and Addenda, hereby offer to construct the Work in accordance with the foregoing Documents for the sum of:

\_\_\_\_\_  
 \_\_\_\_\_/100 dollars

(\$ \_\_\_\_\_) (excluding GST) in lawful money of Canada, which price includes, costs for all changes required by the following Addenda (if any) issued during the Tender period:

Addendum \_\_\_\_\_ Date \_\_\_\_\_

Addendum \_\_\_\_\_ Date \_\_\_\_\_

Addendum \_\_\_\_\_ Date \_\_\_\_\_

Addendum \_\_\_\_\_ Date \_\_\_\_\_

and the applicable taxes in force at this date except as may be otherwise provided in the Tender Document.

**3. OBLIGATIONS**

If awarded the Contract, the Tenderer agrees to:

**3.1 Date of Completion**

3.1.1 Complete to the best of the Tenderer's ability, all of the Work herein set forth to the entire satisfaction of the Contract Administrator within the working days and dates specified in Item 16., Completion Date, of Section 2, Instructions to Tenderers.

3.1.2 Commencement of work shall be established as fourteen (14) days after the date of notification in writing by the Owner (or Contract Administrator) that this Tender has been accepted, or on an otherwise mutually accepted date as indicated in Item 15. of Section 2.

**3.2 Execution**

3.2.1 Execute a formal Contract and furnish any required performance and/or labour material payment bonds, within 10 days notification that this Tender has been accepted.

**4. ENCLOSURES**

The Tenderer encloses herewith:

**4.1 Bid Security**

4.1.1 A bid bond/ Irrevocable letter of credit/ certified cheque in favour of the Owner, in an amount not less than 10% of the Total Tender Price as bid security.

4.1.2 In the event of this Tender being accepted within 60 calendar days of the time stated for the closing of receipt of Tenders, and the tenderer failing or declining to enter into a formal Contract, this bid security shall be forfeited to the Owner.

**5. DECLARATIONS**

The Tenderer declares that:

5.1 Collusion or Fraud

5.1.1 This Tender is made without any connection, comparison of figures with, or knowledge of any other corporation, firm or person submitting a Tender for this Work, and is in all respects fair and without collusion or fraud.

5.2 Site Visit

5.2.1 A responsible representative of the Tenderer's Firm visited the site of the proposed Works and is acquainted with all conditions that may affect the Work.

5.3 Statutory Declaration re: Tender

5.3.1 The Statutory Declaration re: Tender (enclosed in Section 4) has been executed and the matters stated in the foregoing Tender are in all respects true.

**6. AGREEMENTS**

The Tenderer agrees that:

6.1 Validity of Tender

6.1.1 The prices quoted in this Tender are valid and open for acceptance by the Owner for a period of 60 calendar days from the time stated for the closing of receipt of Tenders.

6.2 Owner's Right

6.2.1 The Owner reserves the right to reject any or all Tenders, not necessarily accept the lowest Tender, or to waive formalities, informalities or technicalities in any Tender in the interest of the Owner.

**7. SIGNATURES**

Dated this \_\_\_\_\_ day of \_\_\_\_\_, 20\_\_\_\_.

\_\_\_\_\_  
\_\_\_\_\_  
\_\_\_\_\_

(Signature of Witness)

\_\_\_\_\_  
\_\_\_\_\_  
\_\_\_\_\_

(Signature of Tenderer)

(Seal)

## NOTE:

- .1 If the Tender is submitted by or on behalf of a corporation, it must be signed in the name of such by the duly authorized officers, witnessed, and the seal of the corporation must be affixed. If the Tender is submitted by or on behalf of an individual or partnership, the signature(s) must be witnessed and a seal affixed opposite the signature(s).
- .2 The Owner may require evidence of the authority of any person purporting to sign a Tender on behalf of a person, firm or corporation, whether as principal, agent or attorney.



**8. SCHEDULE OF UNIT PRICES**

The bidder must bid on both options for the tender to be accepted. Please list your subcontractors in SCHEDULE OF SUBCONTRACTORS.

Item Description		Payment Terms	Qty.	Unit	Unit Price (\$)	Total Price (\$)
1.	Ditching, landscaping and seeding in accordance with the drawings and specs	NA	1	LS	\$	\$
<b>SUBTOTAL</b>					\$	
<b>GST (5%)</b>					\$	
<b>TOTAL</b>					\$	

Notes: See SECTION 7. Specifications for the seed mix requirements

PROPOSED START DATE: \_\_\_\_\_

PROPOSED COMPLETION DATE: \_\_\_\_\_

\_\_\_\_\_  
 Signature of Bidder

**9. SCHEDULE OF EQUIPMENT, LABOUR, MATERIALS AND ASSOCIATED RATES**

We agree that the City will use rates indicated below as a basis for Extra Work and Down Time payments.

Item (Material, Labour, Equipment, Etc.)	Rate (\$)	Hourly/Daily/Cubic Yard/Etc.

\_\_\_\_\_  
Signature of Bidder

**10. SCHEDULE OF SUBCONTRACTORS**

The following are the Subcontractors we propose to use for the Work listed:

Subtrade Section	Name and Address

\_\_\_\_\_  
 Signature of Bidder

**11. SCHEDULE OF QUALIFICATIONS/REFERENCES**

Project	Location and Description

\_\_\_\_\_  
Signature of Bidder

**12. BIDDER’S PROPOSED ALTERNATIVES**

Use additional pages if needed. Sign every page and submit with Bid Form.

\_\_\_\_\_  
Signature of Bidder

**13. TRAFFIC MANAGEMENT PLAN**

The Traffic Management Plan is required to demonstrate that the contractor will be able to provide access to residents and manage vehicular and pedestrian traffic volumes in a safe manner at all times during construction.

The information to be included in the Plan is as follows:

1. Order of works (staging) with estimated time to complete each stage;
2. Proposed location of barricades and signage (barricades and signs to be provided by the contractor);
3. Proposed location for parking equipment and storing materials during the construction period;
4. Proposed direction of traffic;
5. Proposed location of flag persons (if required);
6. Temporary roads (if applicable);
7. Location of temporary parking (if applicable).

**14. TREE PROTECTION PLAN AGREEMENT**

Please review the Tree Protection Plan (SECTION 7. Specifications). By signing, you agree to the following:

- Follow all restrictions as described Tree Protection Plan.
- Notify all subcontractors working on site of the Tree Protection Plan and ensure they are aware of the work restrictions zones.
- Ensure all prescriptions are followed.
- Notify the Parks and Urban Forestry Manager for amendments, changes, or additional requests.

*I have read the Tree Protection Plan outline and agree to follow all guidelines within it. I will carry out development activities in accordance with the approved Tree Protection Plan for my site.*

\_\_\_\_\_  
 DATE

\_\_\_\_\_  
 BIDDER'S NAME (PLEASE PRINT)

\_\_\_\_\_  
 BIDDER'S SIGNATURE

\_\_\_\_\_  
 PHONE NUMBER

\_\_\_\_\_  
 EMAIL ADDRESS

\_\_\_\_\_  
 COMPANY NAME

**SOUTH RAILWAY ST DITCHING**  
 PROJECT

END OF SECTION

---

SOUTH RAILWAY ST DITCHING  
CONTRACT 4-2023  
SECTION 5. GENERAL CONDITIONS

---

Use City of Morden General Conditions For Construction Contracts



SOUTH RAILWAY ST DITCHING  
CONTRACT 4-2023  
SECTION 6. SUPPLEMENTARY CONDITIONS

---

1. GENERAL .....2

2. ADDITION AND DELETION OF WORKS .....2

3. DIRECTION OF WORK.....2

4. EXTRA WORK .....2

5. DOWN TIME.....2

6. NIGHT WORK .....3

7. LAYING OUT WORK.....3

8. CHANGES TO DRAWINGS.....3

9. SITE REVIEW.....3

10. PERMITS.....3

11. PROTECTION AND SAFETY PRECAUTIONS .....4

12. CO-OPERATION WITH OTHERS .....4

13. TRAFFIC CONTROL AND MAINTENANCE ACCESS.....4

14. DUST AND NOISE .....5

15. EXISTING SERVICES AND UTILITIES .....5

16. CONTRACTOR TO NOTIFY UTILITIES AND OTHER AUTHORITIES.....5

17. CLEARING OF SITE.....5

18. EXISTING TREES, SHRUBBERY .....6

19. EASEMENTS .....6

20. DAMAGE TO STREETS AND STRUCTURES .....6

21. OPERATING VALVES ON WATERMAIN.....6

22. SURFACE RESTORATIONS.....6

23. TEMPORARY UTILITIES.....7

24. WATER USED BY CONTRACTOR .....7

25. PROTECTION OF SURVEY BARS.....7

26. FINAL CLEAN-UP .....7

27. WARRANTY PERIOD .....7

**1. GENERAL**

The City of Morden General Conditions for Construction Contracts, amended and supplemented as set forth herein after, governs the Work.

**2. ADDITION AND DELETION OF WORKS**

- 2.1 The City reserves the right to delete portions of the tendered work, prior to contract award, if the project costs exceed the budgeted amount.
- 2.2 The City reserves the right to increase or decrease the quantity of any Unit Price item, alter the route or alignment, and make any modifications to the quantities of the contract items that it deems necessary and in its best interest.
- 2.3 Approvals for some works may be subject to the City's success for funding approval or cost sharing agreements as noted elsewhere.
- 2.4 Such modifications and changes shall not constitute grounds to change the value of any unit prices agreed in the contract for these items.

**3. DIRECTION OF WORK**

The Contractor shall carry out the Contract in such a manner that may appear to them as the most desirable, the City at their discretion may direct the order in which and points at which the work shall be undertaken. This control shall be exercised in the interests of the City and it is intended that an agreement be reached between all parties prior to the commencement of the Contract. A Schedule of Work shall be drawn up for this purpose by the Contractor.

**4. EXTRA WORK**

When extra work is to be performed on a cost plus percentage basis, the amount to be paid shall be determined as follows:

- 4.1 To the total of direct labour cost and materials cost, a fee of ten percent (10%) shall be added as full compensation for overhead and all other indirect costs and profit.
- 4.2 Direct labour cost shall include wages, unemployment insurance, workmen's compensation, vacation pay, pension payments and other agreed fringe benefits.
- 4.3 Material costs shall be at trade list or invoiced cost whichever is the lesser,
- 4.4 Equipment cost shall be paid for at the rates agreed to by the City. No percentage shall be added to the agreed rates.

**5. DOWN TIME**

In the event that the Contractor is unable to work on the project, the City may pay Down Time according to the following:

- 5.1 It is the Contractor's responsibility to engage in other works to limit, or eliminate, Down Time. This may mean moving off-site to a different project or relocating to other works on the site. Down Time will not apply to the time required to move equipment and manpower around on the site.
- 5.2 That Down Time will be assessed on the basis of this Contract and may include a detailed review of all associated documents.

- 5.3. Down Time must be agreed and recorded by the Engineer and will apply to any equipment and labour actually on site and that are normally required for the work at hand. The City reserves the right to require a list of equipment and manpower, and associated hourly rates from the Contractor.
- 5.4. That Down Time will not apply to the time required by the Engineer to assess the conditions and claims unless this time exceeds one (1) hour.

**6. NIGHT WORK**

Night work will only be performed by the Contractor if the permission is given beforehand by the appropriate authorities. When work is carried out at night, the Contractor shall supply a sufficient number of electric or other appropriate lights to enable the work to be done in safe and satisfactory manner.

**7. LAYING OUT WORK**

- 7.1. The City will provide reference points to permit the Contractor to complete its own layout.
- 7.2. The City may, at Contractor’s request, provide survey layout. The Contractor is responsible to check and confirm the accuracy for its use.
- 7.3. The Contractor, upon entering the site for the purpose of beginning work, shall locate all reference points and take all necessary precautions to prevent their destruction. The Contractor shall pay all restoration charges for damaged legal survey bars, stakes, markers, etc.
- 7.4. Before commencing work, the Contractor shall satisfy themselves as to the meaning and correctness of all stakes, markers and grade sheets. The City is not to be held liable for mistakes, errors, omissions due to layout.

**8. CHANGES TO DRAWINGS**

- 8.1. The Contractor shall maintain one set of working drawings, shop drawings, details and specifications on the site at all times.
- 8.2. In the event of discovering any new site conditions that may affect the design, The Contractor must notify The City immediately.
- 8.3. If drawings are amended, replace originals with amended sheets.

**9. SITE REVIEW**

- 9.1. All workmanship and all materials furnished and supplied under SPECIFICATIONS are subject to site review and testing by the City including all operations from the selection and production of materials through to final acceptance of the specified work.
- 9.2. The Contractor shall be wholly responsible for the control of all operations notwithstanding any site review or approval that may have been previously given.
- 9.3. The City reserves the right to reject any materials or works which are not in accordance with the requirements of the Specifications.

**10. PERMITS**

**The Contractor shall comply with, and the work shall be carried out, subject to all regulations and orders made by any Municipal, Provincial, Federal or other governmental authority and applicable**

to the said work, and shall, at his own expense, obtain all necessary permits required (including CP Railway).

## 11. PROTECTION AND SAFETY PRECAUTIONS

- 11.1. The Contractor shall provide the necessary precautions to safeguard against any fire or explosion hazards during construction. The Contractor shall further provide adequate safety protection for personnel engaged in this work and for all others who are exposed to the work environment under this Contract.
- 11.2. Adequate and sufficient guards for the prevention of accidents shall be installed and maintained by the Contractor at the construction site. The Contractor shall further provide adequate and sufficient safety lighting at night and during periods of poor visibility.
- 11.3. In the event of an accident occurring at or on the works, the Contractor shall be bound to immediately provide such medical services, including ambulance, as shall ensure proper care being given to the injured party.
- 11.4. The Contractor shall assume full responsibility for, and be liable for, any loss, injury or damage incurred to abutting property, structures, vehicles, pedestrians and animals caused through neglect by the Contractor or his employees during construction operations.

## 12. CO-OPERATION WITH OTHERS

- 12.1. The Contractor's attention is directed to the fact that other Contractors, the personnel of other utilities and the staff of the City may be working in the areas on or adjoining the site.
- 12.2. The activities of these agencies may coincide with the Contractor's execution of the work, and It will be the Contractor's responsibility to co-operate to the fullest extent with personnel working in the area, and such co-operation is an obligation of the Contractor under the terms of this Contract.

## 13. TRAFFIC CONTROL AND MAINTENANCE ACCESS

- 13.1. It will be the responsibility of the Contractor under the Contract to maintain traffic during the entire period of the Contract and to ensure that maximum protection is afforded to the road user and that the Contractor's operations in no way interfere with the safe operation of traffic.
- 13.2. Where deemed necessary by the City a temporary access roadway shall be provided by the Contractor for any residence or building that does not have an alternate means of vehicular access. The access roadway shall also be maintained, removed and the site thoroughly cleaned up on completion by the Contractor. The cost of this work shall be borne by the Contractor.
- 13.3. The City can provide cones, barricades and signs, and may assist with the initial setup. The Contractor must contact the City to determine availability. The Contractor shall maintain all applicable traffic control devices in accordance with Work Zone Traffic Control Manual, Manitoba Transportation & Government Services, Latest Edition.
- 13.4. The Contractor shall provide and maintain flagmen in accordance with the above mentioned *SPECIFICATIONS*.
- 13.5. The Contractor shall take all other safety measures necessary to cope with any peculiar or unusual circumstances which have not been set out in the above mentioned *SPECIFICATIONS*.

- 13.6. Improper signing will be sufficient reason for the City to immediately shut down the entire job. Working days will be assessed during the period of shut-down.
- 13.7. Barricades supplied and installed by the Contractor in the performance of the work must clearly show the name of the Contractor and the telephone number(s) at which he can be reached twenty-four (24) hours a day, seven (7) days a week.
- 13.8. During the hours when the Contractor is not working, equipment and stockpiled material shall be left in such a location so as not to Interfere with or present a hazard to motorists or pedestrians.

#### **14. DUST AND NOISE**

- 14.1. The Contractor shall take such steps as may be required to prevent dust nuisance resulting from his operations whether within the right-of-way or elsewhere or by public traffic where it is the Contractor's responsibility to maintain a roadway throughout the work.
- 14.2. The Contractor shall always reduce noise to as great an extent as possible . Air compressing plants shall be equipped with silencers and the exhausts of all gasoline motors or other power equipment shall be provided with mufflers.

#### **15. EXISTING SERVICES AND UTILITIES**

- 15.1. No responsibility will be assumed by the City for correctness or completeness of the DRAWINGS with respect to the existing utilities, pipes or other objects either underground or on the surface, and the City shall be liable for the incorrectness and inadequacy thereof. It shall be the responsibility of the Contractor to determine the location of all such utilities, pipes and other objects and to make good any damage done to them.
- 15.2. The City will arrange for the relocation of existing utilities, poles, traffic signals, signs and lamp posts which interfere with the proposed construction. The City will be responsible for the cost of this relocation.
- 15.3. The Contractor shall make the necessary arrangements for and pay the cost of all relocation required for their convenience.

#### **16. CONTRACTOR TO NOTIFY UTILITIES AND OTHER AUTHORITIES**

- 16.1. Whenever the work requires sub-cutting or any kind of excavation, the Contractor shall, before entering on the work, make application to each utility, or other authorities and obtain necessary locates/ approvals prior to commencement of work.
- 16.2. The Contractor shall maintain accurate record of these locates/approvals. The City shall have access to these records.

#### **17. CLEARING OF SITE**

The Contractor, at their own expense, shall be required to do all clearing of bush, leveling snow, etc., for the proper execution of the work under this Contract. All refuse, bush, etc., shall be disposed of in a manner satisfactory to the City. The Contractor shall make themselves fully aware of the conditions in the work area prior to submitting their Bid and no payment will be made for any work required as per this Item.

**18. EXISTING TREES, SHRUBBERY**

No trees whatsoever shall be cut down without the written permission of the City. Trees, shrubbery, fences, poles and all other private property and surface structures shall be protected unless their removal is shown on the drawings or authorized by the City. When it is necessary to cut roots and tree branches, such cutting shall be done under the supervision and direction of the City. Any damage to trees as a result of Contractor negligence will be remedied by the City at the expense of the Contractor.

**19. EASEMENTS**

No work whatsoever shall be performed in an easement or other property not owned by the City without written permission from the City. No claim shall be made by the Contractor on account of such permission not being granted.

**20. DAMAGE TO STREETS AND STRUCTURES**

- 20.1. Other than what is required to be done by the Contractor under the work of this Contract, all necessary precautions shall be exercised by the Contractor so as not to remove, disturb, or damage any existing pavements, streets, roads, boulevards, poles, hydrants, water pipes, gas pipes, electrical wires, cables, conduits, sewers or other existing facilities and equipment at the site of the work.
- 20.2. For all damage incurred thereto in the performance of the work, the Contractor shall upon instructions from and to the satisfaction of the City and the City's Contract Administrator thereof, either replace or repair such damage, whichever may be deemed necessary in the opinion of, and acceptable to, the City and the City's Contract Administrator thereof and the costs of which shall be borne entirely by the Contractor.
- 20.3. The Contractor shall also indemnify and save harmless the City from all claims made directly or indirectly against it in respect to any such damage.
- 20.4. Any manhole rims or valves that are located within the finished pavement surface or boulevard areas shall be adjusted to match the finished surface. This work shall be incidental to the contract.

**21. OPERATING VALVES ON WATERMAIN**

Upon receipt of adequate notice, City work forces shall turn existing watermains off and on as required for the Contractor, at no cost to the Contractor. At no time shall the Contractor operate the valves on the existing watermain system or new valves tied into the existing system.

**22. SURFACE RESTORATIONS**

- 22.1. Unless otherwise specified, the Contractor shall be responsible for all surface restoration equal to or better than the original condition.
- 22.2. The Contractor shall make themselves fully aware of the conditions in the work area prior to submitting their Bid and no payment will be made for any work required as per this item.
- 22.3. Arrangements shall be made by the Contractor with the Authority concerned regarding restoration of surfaces, where such surface restoration is not specifically detailed herein. The Contractor shall bear the full expense involved in replacing the surfaces to the satisfaction of the Authority having jurisdiction.

22.4. Any ditches that may be disturbed shall be graded and restored upon completion. Ditch grades shall be as determined by the City or by the Authority having jurisdiction over the roadway, and in general, will be as shown on the drawings. The Contractor will also be responsible to maintain the drainage of the existing ditches during the construction period. Surface restoration and clean-up shall be done block by block immediately behind the installation crews.

### **23. TEMPORARY UTILITIES**

The Contractor will be required to make their own arrangements in connection with the temporary use of lighting, power, gas, sewer, water or other utilities, and pay all costs in connection therewith. All necessary permits, fees, etc., as well as the cost of temporary connections to existing facilities shall be arranged for and paid for by the Contractor.

### **24. WATER USED BY CONTRACTOR**

Water for use by the Contractor, shall be obtained from the City at the prevailing rates. The Contractor shall arrange with the City as to the hydrants available for their use. Other sources of water may be used only after special written permission has been received from the City. The City may meter used water for accounting or billing purposes.

### **25. PROTECTION OF SURVEY BARS**

- 25.1. The Contractor shall not disturb, deface, alter, destroy or remove any survey post, monument or bar and if the same shall occur, then, and in every such case, the City shall have such post, monument or bar replaced at the expense of the Contractor. The Contractor shall pay all costs and expenses incurred in connection therewith.
- 25.2. If the Contractor is in doubt about the location of the bars in the field, they will contact the City before doing any work in the area. Other survey posts, monuments, or bars may exist and the Contractor shall exercise care at intersections and other places where such survey posts, monuments or bars may exist.
- 25.3. Where a survey bar lies in the line of the proposed work and must be disturbed, the Contractor shall provide the City with 72 hours notice to have the survey bar referenced and relocated. The survey bar shall be referenced and replaced at no cost to the Contractor.

### **26. FINAL CLEAN-UP**

At the completion of the construction work, all areas on which work has been done shall be left in a neat and presentable condition. All drainage ditches which have been blocked as a result of the work shall be restored to their original condition or better. The Contractor, at their own expense, shall be responsible for off-site disposal of all surplus excavated material, trees, debris, brush, rock, boulders and asphaltic cement concrete.

### **27. WARRANTY PERIOD**

- 27.1. For the warranty period the Contractor shall be responsible for faulty material and/or workmanship, for maintenance and corrections as a direct result of faulty material and/or workmanship.
- 27.2. After due notification in writing to the Contractor, the City may proceed with correction of a fault at the expense of the Contractor. In emergency situations endangering life or public property, the

City shall proceed with repairs and thereupon advise the Contractor of the failure. The resulting costs shall be paid by the Contractor.

27.3. When submitting their Bid, the Contractor shall note that all his work, including any extra work as specified herein, shall be subject to the warranty period requirements.

27.4. Warranty period is twelve (12) months from the date of the issuance of Certificate of Completion.

END OF SECTION

---



SOUTH RAILWAY ST DITCHING  
CONTRACT 4-2023  
SECTION 7 - SPECIFICATIONS

---

1. UNIT PRICE CLARIFICATIONS .....	1
2. SEED MIX.....	1

**1. UNIT PRICE CLARIFICATIONS**

- 1.1. All prices must include the materials, labour, equipment, and tools required to complete the Works according to the specifications, except where the following explicitly state otherwise.
- 1.2. The Engineer will not approve payment until all materials and performance testing has been received and approved. Any rejected or reworked sections must be completed to the Engineer's satisfaction and at the Contractor's expense.
- 1.3. If there is a disagreement between the Contractor's and the Engineer's measurements of the works, the Engineer's measurements will be taken to be correct.
- 1.4. The Contractor is responsible for disposal of all excavated material.

**2. SEED MIX**

Seed mixes approved for the project are the following:

- **Streambank Mix:**
  - 17%Streambank Wheat Grass
  - 16%Big Blue Stem
  - 33% Fleet Meadow Brome grass
  - 17% Glacier Orchard grass
  - 7%Survivor Alfalfa
  - 7%Creeping Red Fescue
  - 3%Troy Kentucky Blue grass
  
- **Grassed Run ways / all purpose (from CO-OP)**
  - 50%Fleet Meadow Brome grass
  - 25%Glacier Brand Orchard Grass
  - 10%Survivor Alfalfa
  - 10%Creeping Red Fescue
  - 5%Troy Kentucky Blue Grass

Any proposed changes to the above mixes must be submitted by the contractor to the City for approval prior to the tender submission.

SOUTH RAILWAY ST DITCHING  
CONTRACT 4-2023  
SECTION 8 - DRAWINGS

---



# TREE PROTECTION POLICY

A Guide for Public Tree Protection

City of Morden, Parks and Urban Forestry

## Tree Protection Policy Guidelines

### Introduction

The City's Urban Forest Management Plan (UFMP) falls under the 2018-2022 City of Morden Corporate Plan, section 2 Environmental Management. The purpose of the UFMP is to utilize the city-wide public tree inventory data to provide a framework for sustainably managing and enhancing the City of Morden's urban forest now and in the future.

Multiple benefits are provided by our urban trees and we understand trees have positive effects on; air quality, noise reduction, storm water management, property values, wildlife habitat, energy consumption, climate moderation, and links to the health and well being of our citizens. One way in which to conserve these benefits is through tree protection during the planning, construction, and post constructions phases of development.

### What is a Tree Protection Plan?

A Tree Protection plan is a written directive included in the construction plans and specifications to control work around protected trees during all phases of the project.<sup>1</sup> A protected tree is designated as such by the City Forester and determined using the criteria in a Tree Resource Assessment. This assessment will take place upon receipt of the application or notification for a development permit, capital infrastructure project, utilities works, and or repairs to infrastructure in which a tree is located within 6 meters or 20 feet of the work area. The tree resource assessment will determine the requirement for a Tree Protection Plan. Under this plan, it is the intention for the City and the property owner (or their authorized agent) to formalize an agreement with respect to tree protection for all phases of development. The agreement will outline the construction practices necessary to conserve the benefits by minimizing the impacts from the construction process.

Impacts on trees resulting from construction activities may involve one or more of the following:

- Physical contact with any living parts of the tree.
- Soil compaction.
- Changes in surface grade.
- Changes in exposure.
- Stockpiling of materials in the root zone.
- Changes to the ground water flow, supply or quality.

<sup>1</sup>American National Standard for Tree Care Operations – Tree, Shrub, and Other Woody Plant Management – Standard Practices (Management of Trees and Shrubs During Site Planning, Site Development, and Construction). ANSI 300 (Part 5) – 2012

### **Section 1: Tree Ownership Determination**

It can be assumed that trees within the street right-of-way are public or city owned trees. However, for the purposes of the Tree Protection Plan all trees within 6m or 20 feet of the property line require a tree ownership determination. This will be provided by the Parks and Urban Forestry department and communicated in writing. This communication will indicate if no public trees exist or provide a Tree Resource Assessment to the property owner.

### **Section 2: Tree Resource Assessment (TRA)**

An ISA certified and Tree Risk Assessment Qualified arborist will conduct a Tree Resource Assessment. The information with the assessment will include:

- Tree Condition
- Tree Genus and Species
- Tree Diameter in cm at DBH
- Tree Canopy (height, width, condition)
- Tree Location(s)
- Tree Risk Assessment
- Tree Appraisal (CTLA Trunk Formula Method)

The TRA can be supplied by the City of Morden, Parks and Urban Forestry department upon written request by the property owner. If a consulting arborist is used for the TRA, the property owner must supply the name and credentials including a copy of certifications or ISA number. Upon completion of the TRA by a consulting arborist a copy must be submitted to the City Urban Forester for approval and is subject to an audit for accuracy.

### **Section 3: Tree Protection Plan (TPP)**

A Tree Protection Plan helps to define the steps taken during the construction process to avoid impacts on tree health and condition while ensuring the continuation of the benefits to the community.

#### **Tree Protection Plan Check List**

##### **Site Plan**

- Location of all existing trees and shrubs within 6m of the development site, include tree height and diameter.

- Indicate the Tree Protection Zone and Root Protection Zone location and distances for each tree.
- Construction materials storage area(s).
- The excavation zones, trenching, grade changes, underground utilities and irrigation systems, sidewalks, driveways, parking lots, construction access roads, changes to hydrants, lighting, and utilities.
- Soil compaction reduction treatments and areas.
- Drainage plan

 **Tree Protection Zone (TPZ)**

The Tree Protection Zone is the area surrounding a tree defined by a specified distance, in which excavation, compaction, stockpiling and other construction related activities shall be avoided. Its function is to protect all living parts of the tree and the surrounding soil. Table 1 indicates the minimum distances for establishment of a TPZ. In the event of a modification to the TPZ, notification shall be given to the City Forester. The City will determine if the modifications to the TPZ are acceptable and make any further recommendations through communication with the property owner or designate.

Table 1 Tree Protection Zones				
Diameter of Trunk (DBH) in cm		Minimum Protection Distances Required		
		(m)	(ft)	
<10		2.13	7	
10 - 30		2.44	8	
31 - 50		3.05	10	
51 - 60		3.65	12	
61 - 70		4.26	14	
71 - 80		4.87	16	
81 - 90		5.48	18	
91 - 100+		6.10	20	

1. Diameter at Breast Height (DBH) measurement is taken around the trunk at 1.4m from the ground.
2. Roots can extend from the trunk 2-3 times the distance of the drip line.
3. Tree Protection Zone distances are measured from the outside edge of the trunk flare at the base of the tree outwards towards the drip line.
4. Information is based on – Parks and Open Space, City of Oakville Ontario. Tree Protection Specifications for Construction Near Trees, 2008.

 **Tree Protection Barriers**

In addition to the Tree Protection Zone establishment using table 1, a physical barrier must be placed on site at the minimum required distance from the protected tree. Tree protection barriers must be erected prior to any construction related activities. Approval from the City Forester is required for the alteration and/or removal of the tree protection barrier.

The barrier must be a minimum of 1.5m tall above ground and located on all sides of the tree. The height may be adjusted if existing tree limbs are below 1.5m and adjusted to align with streets, curbs, and pedestrian traffic flow. Barrier material may be orange snow fence with a 2x4 constructed frame/staking or a suitable restrictive substitute.

Signage shall be posted on each side the barrier with the following information

### **TREE PROTECTION ZONE**

**Grade changes, material storage or equipment are NOT permitted in this area**

City of Morden (logo)

204.362.3999

#### **Root Protection Zone**

The Root Protection Zone is the soil area surrounding a tree defined by a specific measurement, in which excavation, compaction and other construction related activities should be avoided or mitigated. The RPZ is typically made up of the TPZ and may extend beyond the TPZ. It is known that the root system of a tree may extend from the trunk 2-3 times the distance of the drip line. Therefore, it's important to take precautionary measures to reduce soil compaction, and plan excavation, trenching and root pruning activities.

The following calculation will be used to determine the RPZ:

$$\text{Diameter (DBH cm)} \times 12 / 100 = \text{RPZ m}$$

*For example a tree with a dbh of 70cm has an RPZ of 8.4m*

#### **Excavation or Trenching**

Any excavation or trenching as indicated on the site plan within the Root Protection Zone should be planned to minimize root damage.

Preferred methods to avoid damage to roots:

Hand excavation with tools: when a root is encountered, avoid contact with the root and excavate around it.



Pneumatic excavation: tools and equipment are available to use compressed and high pressure air to remove the soil around the roots without damaging the larger roots.

Hydraulic excavation: tools and equipment are available to use high-pressure water to wash and remove soil around the roots without damaging larger roots.

Trenchless pipe installation: tools and equipment are available to install pipes of varying diameter under roots without trenching.

### **Root Pruning**

Roots should not be ripped or torn during excavation. Roots 5cm in diameter or greater require approval by the City Forester and removal by a certified arborist.

If possible, avoid root pruning during periods from bud break to leaf development.

Pruning of all Elms is banned between April 1<sup>st</sup> to July 31<sup>st</sup> in Manitoba.

Crown reduction pruning is not an acceptable practice to compensate for loss of roots through root pruning activity.

Roots should be pruned or cut prior to excavation by exposing roots using the above methods.

All exposed or surface roots greater than 40mm diameter damaged at the edge of the TPZ shall be cut cleanly by sawing. Severing or crushing roots by excavator or other mechanical device is not acceptable.

### **Tree Pruning, Removals**

Any planned tree pruning, or removal activities should be identified in the TPP. If pruning is required of City owned trees notification must be given and the City will conduct the pruning activities. In the event that a consulting arborist is hired, the property owner must supply the name and credentials including a copy of certifications or ISA number to the City Forester.

Pruning of all Elms is banned between April 1<sup>st</sup> to June 31<sup>st</sup> in Manitoba.

### **Soil Compaction**

Acceptable standards for compaction mitigation in the Root Protection Zone include; spreading a minimum 6 inch layer of woodchip mulch, adding large plywood or steel sheets over the mulch, laying rubberized matting in the travel areas, operating on frozen soils.

It is important to note that equipment/vehicle/skid steer travel within the RPZ is not recommended during high soil moisture conditions OR when continuous travel routes are needed. It is the goal to protect the soil structure and integrity within the RPZ.

### **Drainage Plan**

Changes in ground water flow and surface water will impact trees. Subdrains, catch basins, outfalls, swales, detention and retention ponds should be identified as part of the Tree Protection Plan. Below ground walls or foundations could disrupt the underground water flow. Run-off from a hardscaped surface, such as a parking lot, could introduce contaminants to the soil water.

### **Contact Information**

Provide contact information for a designated person responsible for ensuring the Tree Protection Plan is followed.

### **Step 1: Pre-Construction Meeting**

A Pre-Construction meeting is the first step in the Tree Protection Plan process. This meeting shall give the property owner the opportunity to share site/construction plans, timing and logistics. In turn, this meeting allows the city to review the TRA and establish the TPZ, RPZ and pre-construction, construction and post-construction requirements.

### **Step 2: Construction**

Construction inspections may occur to ensure the Tree Protection Plan is being followed.

### **Step 3: Post Construction**

Post Construction inspection will occur using the data from the Tree Resource Assessment to establish pre-construction condition and take note of damage to any living parts of the tree. At this point the City Forester will advise on the removal of the Tree Protection Zone barrier(s).

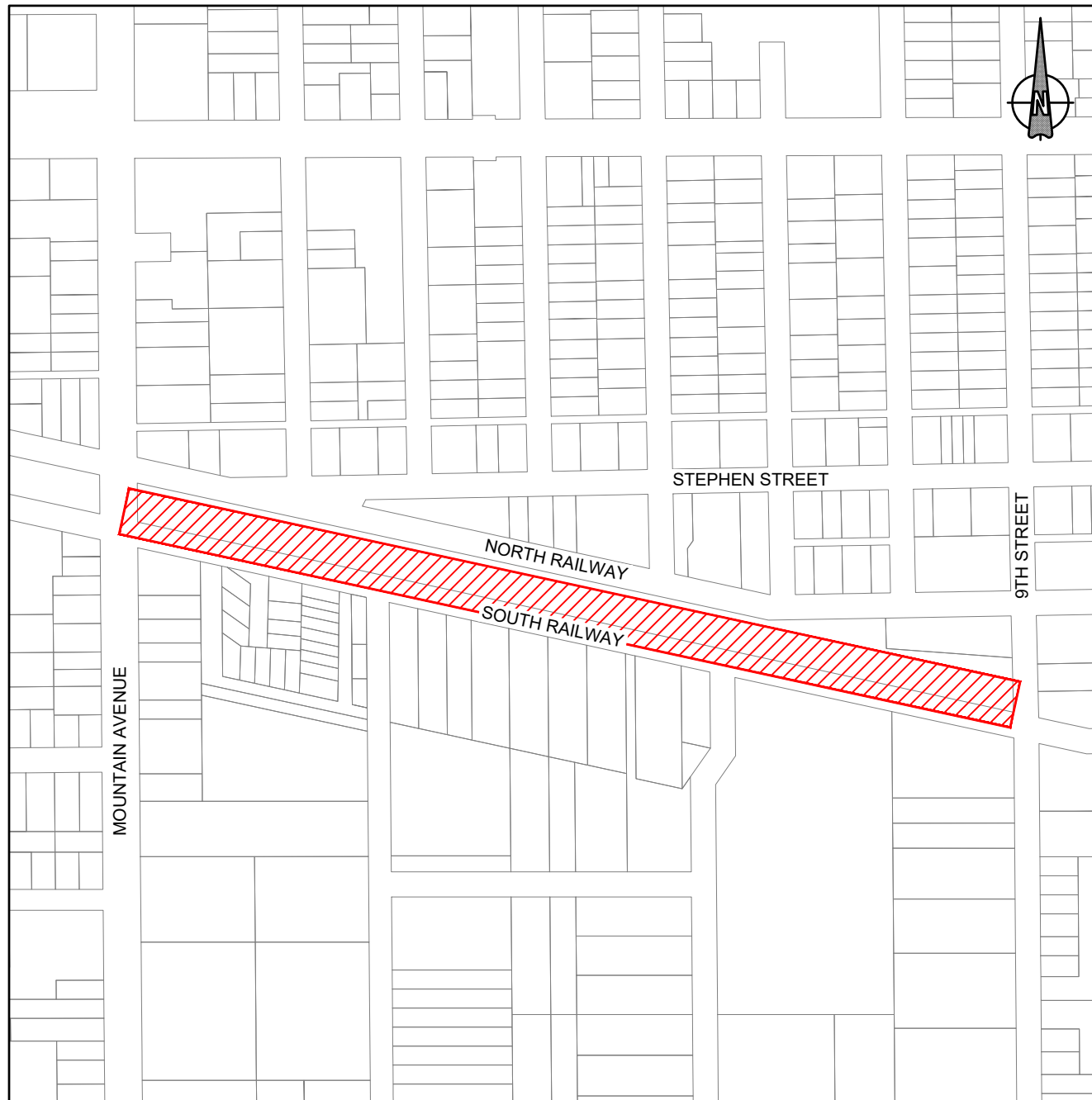

# CITY OF MORDEN

## SOUTH RAILWAY DITCHING

### PLAN INDEX

#### PROJECT SITE

SHEET S01          SITE PLAN

#### PLAN AND PROFILE

SHEET C01          PLAN AND PROFILE STA 1+000 TO 1+390  
SHEET C02          PLAN AND PROFILE STA 1+390 TO 1+775

#### DETAILS

SHEET D01          MISCELLANEOUS DETAILS

**jdb project engineering inc.**

1-880L - 15TH STREET WINKLER, MB R6W 0H5  
PH: (204) 331-4440 EMAIL: jbotha@jdbprojects.ca







PLAN VIEW

SCALE = 1:1000

**LEGEND:**

- |  |                    |  |                       |  |                             |
|--|--------------------|--|-----------------------|--|-----------------------------|
|  | EXISTING WATERMAIN |  | EXISTING FIRE HYDRANT |  | EXISTING DRAINAGE DIRECTION |
|  | PROPOSED WATERMAIN |  | PROPOSED FIRE HYDRANT |  | PROPOSED DRAINAGE DIRECTION |
|  | EXISTING SEWERMAIN |  | EXISTING VALVE        |  | CONTOURS - MAJOR INTERVALS  |
|  | PROPOSED SEWERMAIN |  | PROPOSED VALVE        |  | CONTOURS - MINOR INTERVALS  |
|  | EXISTING GAS LINE  |  | EXISTING MANHOLE      |  | EXISTING GROUND ELEVATION   |
|  | EXISTING MTS LINE  |  | PROPOSED MANHOLE      |  | PROPOSED GROUND ELEVATION   |
|  | MATCH LINE         |  | EXISTING CURBSTOP     |  | EXISTING ROAD ELEVATION     |
|  | ASPHALT            |  | PROPOSED CURBSTOP     |  | PROPOSED ROAD ELEVATION     |
|  |                    |  | EXISTING CATCH BASIN  |  |                             |
|  |                    |  | PROPOSED CATCH BASIN  |  |                             |



**jdb project engineering inc.**

1-880L - 15TH STREET WINKLER, MB R6W 0H5  
 PH: (204) 331-4440 EMAIL: jbotha@jdbprojects.ca



05	TENDER	2023.03.21
04	REVISED DITCH PROFILE	2023.02.23
03	FINAL REVIEW	2022.08.10
02	REVISED DROP STRUCTURE	2022.08.09
01	REVIEW	2022.07.26
REVISION	ISSUED FOR	DATE

PROJECT: SOUTH RAILWAY DITCHING

TITLE: SITE PLAN

**CITY OF MORDEN**  
 133 7TH STREET MORDEN, MB. R6M 1S3  
 PHONE: (204) 822-2562

DESIGNED BY: NG	REVIEWED BY: JB	FIELD BOOK: NONE	SHEET NO: S01
DRAWN BY: NG	DATE: 2022.07.11	SCALE: 1:1000	DRAWING NO: 181



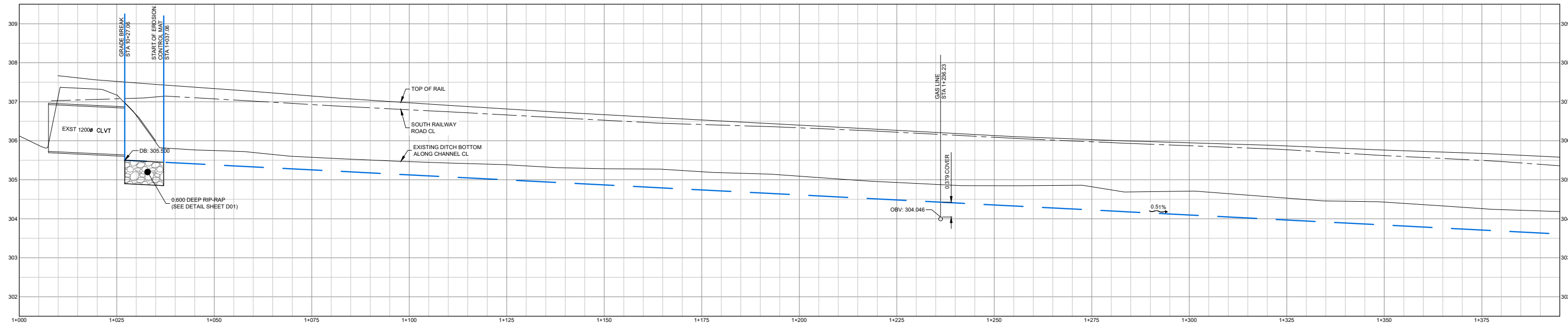

**PROFILE VIEW**

HORIZONTAL SCALE = 1:500  
VERTICAL SCALE = 1:50

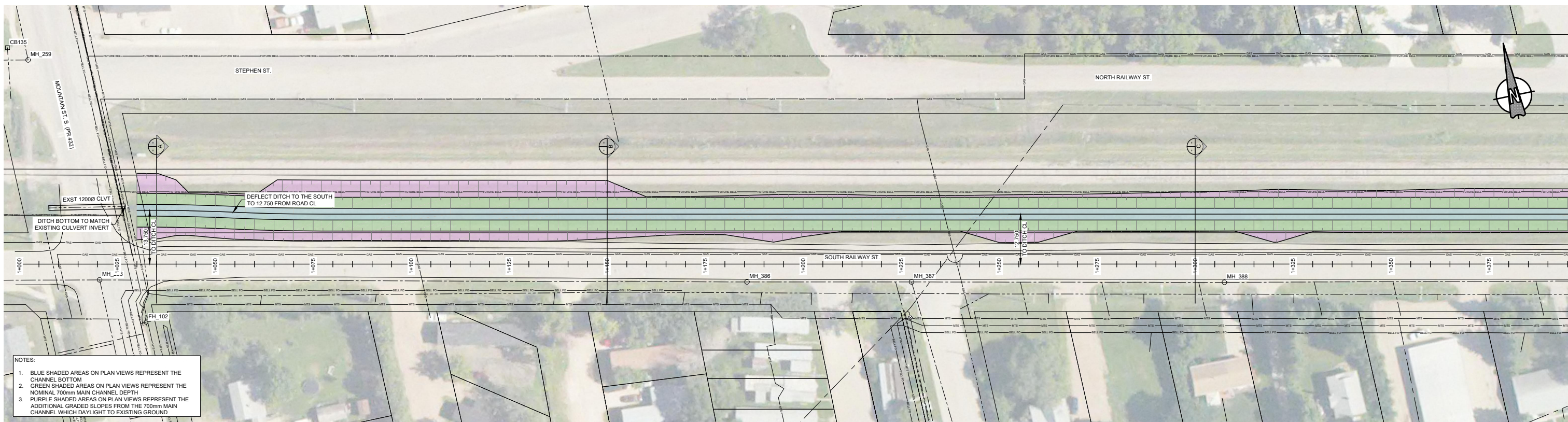

**PLAN VIEW**

SCALE = 1:500

- NOTES:**
1. BLUE SHADED AREAS ON PLAN VIEWS REPRESENT THE CHANNEL BOTTOM
  2. GREEN SHADED AREAS ON PLAN VIEWS REPRESENT THE NOMINAL 700mm MAIN CHANNEL DEPTH
  3. PURPLE SHADED AREAS ON PLAN VIEWS REPRESENT THE ADDITIONAL GRADED SLOPES FROM THE 700mm MAIN CHANNEL WHICH DAYLIGHT TO EXISTING GROUND

LEGEND:	
	EXISTING WATERMAIN
	PROPOSED WATERMAIN
	EXISTING SEWERMAIN
	PROPOSED SEWERMAIN
	EXISTING GAS LINE
	EXISTING MTS LINE
	MATCH LINE
	ASPHALT
	EXISTING FIRE HYDRANT
	PROPOSED FIRE HYDRANT
	EXISTING VALVE
	PROPOSED VALVE
	EXISTING MANHOLE
	PROPOSED MANHOLE
	EXISTING CURBSTOP
	PROPOSED CURBSTOP
	EXISTING CATCH BASIN
	PROPOSED CATCH BASIN
	EXISTING DRAINAGE DIRECTION
	PROPOSED DRAINAGE DIRECTION
	CONTOURS - MAJOR INTERVALS
	CONTOURS - MINOR INTERVALS
	EXISTING GROUND ELEVATION
	PROPOSED GROUND ELEVATION
	EXISTING ROAD ELEVATION
	PROPOSED ROAD ELEVATION

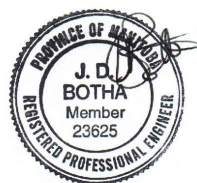

**jdb project engineering inc.**

1-880L - 15TH STREET WINKLER, MB R6W 0H5  
PH: (204) 331-4440 EMAIL: jbotha@jdbprojects.ca



REVISION	ISSUED FOR	DATE
05	TENDER	2023.03.21
04	REVISED DITCH PROFILE	2023.02.23
03	FINAL REVIEW	2022.08.10
02	REVISED DROP STRUCTURE	2022.08.09
01	REVIEW	2022.07.26

PROJECT: SOUTH RAILWAY DITCHING

TITLE: PLAN AND PROFILE VIEW  
STA 1+000 TO 1+390

**CITY OF MORDEN**  
133 7TH STREET MORDEN, MB. R6M 1S3  
PHONE: (204) 822-2562

DESIGNED BY:	REVIEWED BY:	FIELD BOOK:	SHEET NO.:
NG	JB	NONE	C01
DRAWN BY:	DATE:	SCALE:	DRAWING NO.:
NG	2022.07.11	1:500	181



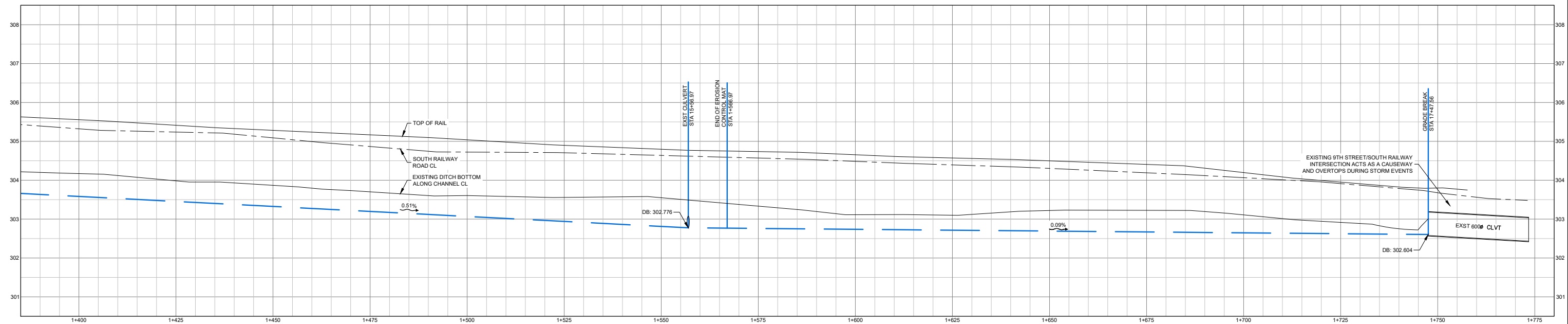

**PROFILE VIEW**

HORIZONTAL SCALE = 1:500  
VERTICAL SCALE = 1:50

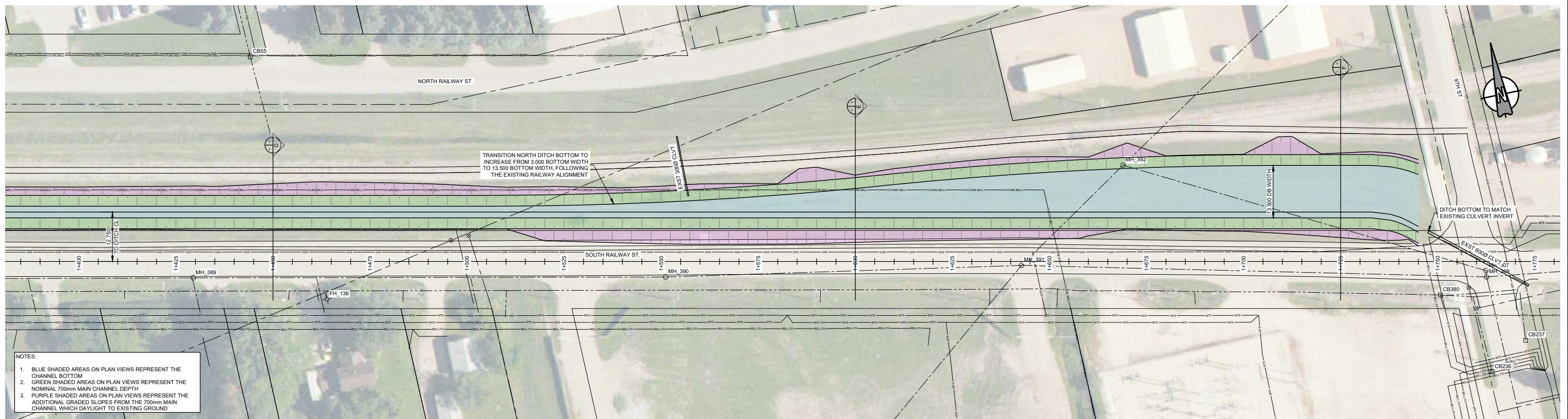

**PLAN VIEW**

SCALE = 1:500

**LEGEND:**

- |     |                    |    |                       |          |                             |
|-----|--------------------|----|-----------------------|----------|-----------------------------|
| --- | EXISTING WATERMAIN | FH | EXISTING FIRE HYDRANT | ---      | EXISTING DRAINAGE DIRECTION |
| --- | PROPOSED WATERMAIN | FH | PROPOSED FIRE HYDRANT | ---      | PROPOSED DRAINAGE DIRECTION |
| --- | EXISTING SEWERMAIN | +  | EXISTING VALVE        | 100      | CONTOURS - MAJOR INTERVALS  |
| --- | PROPOSED SEWERMAIN | +  | PROPOSED VALVE        | 100.5    | CONTOURS - MINOR INTERVALS  |
| --- | EXISTING GAS LINE  | MH | EXISTING MANHOLE      | x 100.00 | EXISTING GROUND ELEVATION   |
| --- | EXISTING MTS LINE  | MH | PROPOSED MANHOLE      | 100.00   | PROPOSED GROUND ELEVATION   |
| --- | MATCH LINE         | MH | EXISTING CURBSTOP     | 100.00   | EXISTING ROAD ELEVATION     |
| --- | ASPHALT            | MH | PROPOSED CURBSTOP     | 100.00   | PROPOSED ROAD ELEVATION     |
|     |                    | CB | EXISTING CATCH BASIN  |          |                             |
|     |                    | CB | PROPOSED CATCH BASIN  |          |                             |

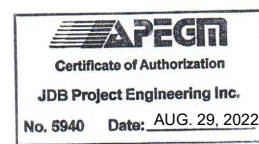

**jdb project engineering inc.**

1-880L - 15TH STREET WINKLER, MB R6W 0H5  
PH: (204) 331-4440 EMAIL: jbotha@jdbprojects.ca



05	TENDER	2023.03.21
04	REVISED DITCH PROFILE	2023.02.23
03	FINAL REVIEW	2022.08.10
02	REVISED DROP STRUCTURE	2022.08.09
01	REVIEW	2022.07.26
REVISION	ISSUED FOR	DATE

PROJECT: SOUTH RAILWAY DITCHING

TITLE: PLAN AND PROFILE VIEW  
STA 1+390 TO 1+775

DESIGNED BY: NG	REVIEWED BY: JB	FIELD BOOK: NONE	SHEET NO: C02
DRAWN BY: NG	DATE: 2022.07.11	SCALE: 1:500	DRAWING NO: 181

**CITY OF MORDEN**  
133 7TH STREET MORDEN, MB. R6M 1S3  
PHONE: (204) 822-2562

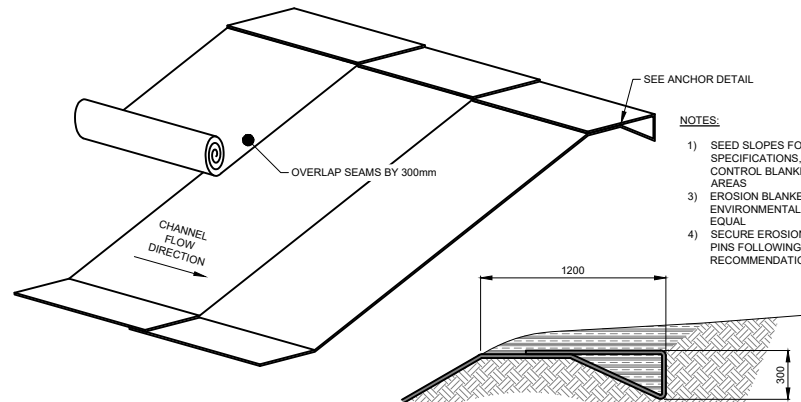

**EROSION CONTROL BLANKET DETAIL**

SCALE = NTS

**NOTES:**

- 1) SEED SLOPES FOLLOWING CITY OF MORDEN SPECIFICATIONS, THEN PLACE EROSION CONTROL BLANKET OVER TOP OF SEEDED AREAS
- 2) EROSION BLANKET TO BE TITAN ENVIRONMENTAL TE-S31 BD OR APPROVED EQUAL
- 3) SECURE EROSION BLANKET TO SLOPES WITH PINS FOLLOWING MANUFACTURER'S RECOMMENDATIONS

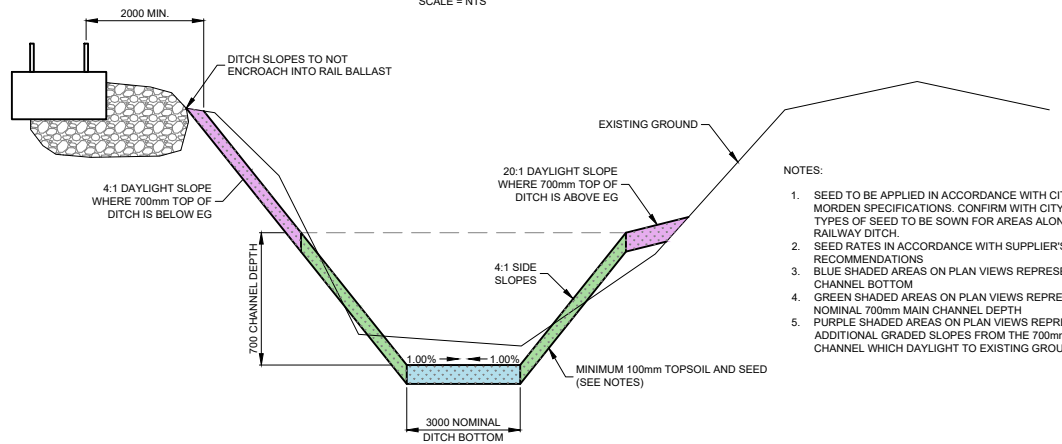

**TYPICAL DITCH CROSS SECTION**

HORIZONTAL SCALE = 1:100  
VERTICAL SCALE = 1:20

**NOTES:**

1. SEED TO BE APPLIED IN ACCORDANCE WITH CITY OF MORDEN SPECIFICATIONS. CONFIRM WITH CITY OF MORDEN TYPES OF SEED TO BE SOWN FOR AREAS ALONG SOUTH RAILWAY DITCH.
2. SEED RATES IN ACCORDANCE WITH SUPPLIER'S RECOMMENDATIONS
3. BLUE SHADED AREAS ON PLAN VIEWS REPRESENT THE CHANNEL BOTTOM
4. GREEN SHADED AREAS ON PLAN VIEWS REPRESENT THE NOMINAL 700mm MAIN CHANNEL DEPTH
5. PURPLE SHADED AREAS ON PLAN VIEWS REPRESENT THE ADDITIONAL GRADED SLOPES FROM THE 700mm MAIN CHANNEL WHICH DAYLIGHT TO EXISTING GROUND

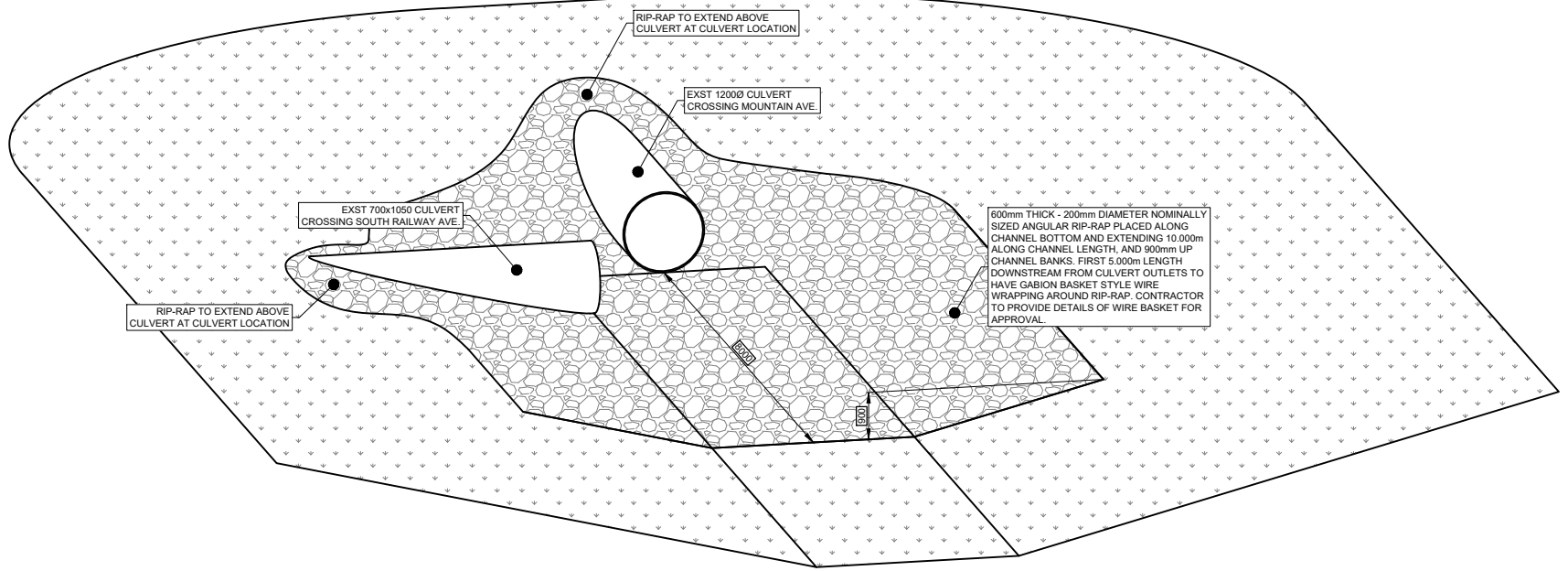

**MOUNTAIN AVENUE RIP-RAP DETAIL**

SCALE = NTS

NOTE: WATER SURFACE ELEVATIONS SHOWN ARE BASED ON A NOMINAL FLOW RATE OF 3.0 CMS. DOWNSTREAM OVERFLOW CONTROL AT 9TH STREET INTERSECTION WAS NOT MODELLED AS PART OF THE SCOPE OF THIS PROJECT AND THE WATER SURFACES SHOWN ARE A NOMINAL FLOW DEPTH BASED SOLELY ON THE CHANNEL GEOMETRY.

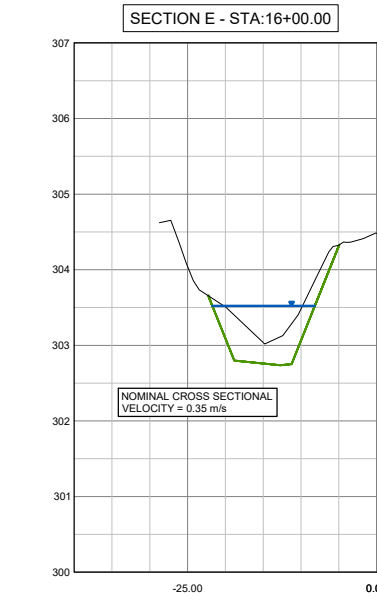
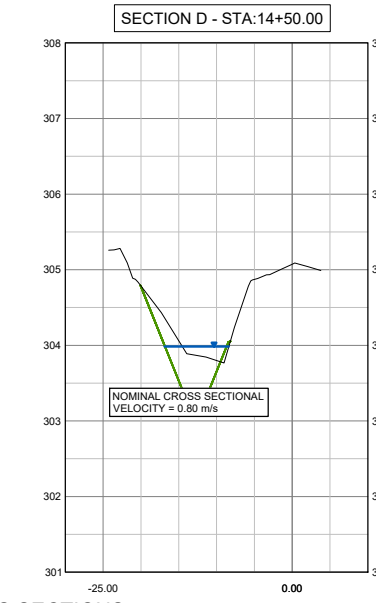
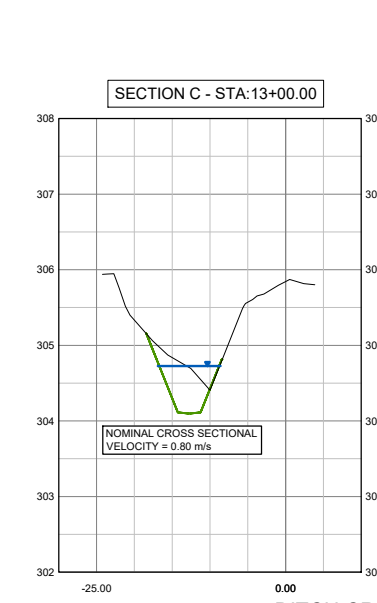
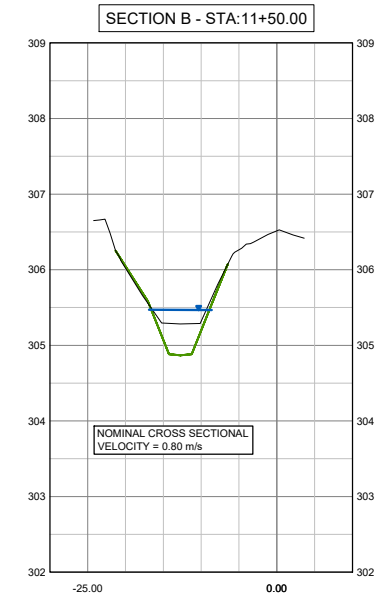
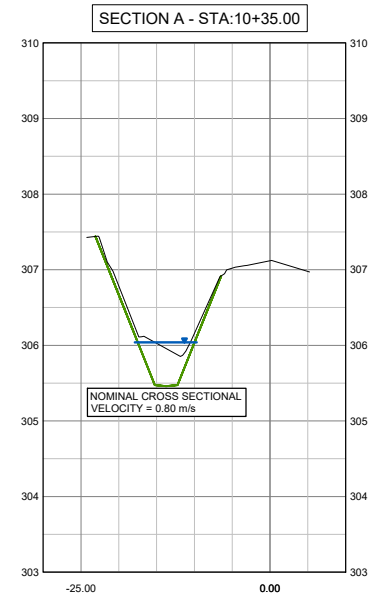

**DITCH CROSS SECTIONS**

HORIZONTAL SCALE = 1:500  
VERTICAL SCALE = 1:50

**LEGEND:**

---	EXISTING WATERMAIN	FH	EXISTING FIRE HYDRANT	---	EXISTING DRAINAGE DIRECTION
---	PROPOSED WATERMAIN	FH	PROPOSED FIRE HYDRANT	---	PROPOSED DRAINAGE DIRECTION
---	EXISTING SEWERMAIN	+	EXISTING VALVE	100	CONTOURS - MAJOR INTERVALS
---	PROPOSED SEWERMAIN	+	PROPOSED VALVE	100.5	CONTOURS - MINOR INTERVALS
---	EXISTING GAS LINE	MH	EXISTING MANHOLE	x 100.00	EXISTING GROUND ELEVATION
---	EXISTING MTS LINE	MH	PROPOSED MANHOLE	(100.00)	PROPOSED GROUND ELEVATION
---	MATCH LINE	CB	EXISTING CURBSTOP	(100.00)	EXISTING ROAD ELEVATION
---	ASPHALT	CB	PROPOSED CURBSTOP	(100.00)	PROPOSED ROAD ELEVATION
		CB	EXISTING CATCH BASIN		
		CB	PROPOSED CATCH BASIN		

FH	EXISTING FIRE HYDRANT
FH	PROPOSED FIRE HYDRANT
+	EXISTING VALVE
+	PROPOSED VALVE
MH	EXISTING MANHOLE
MH	PROPOSED MANHOLE
CB	EXISTING CURBSTOP
CB	PROPOSED CURBSTOP
CB	EXISTING CATCH BASIN
CB	PROPOSED CATCH BASIN

---	EXISTING DRAINAGE DIRECTION
---	PROPOSED DRAINAGE DIRECTION
100	CONTOURS - MAJOR INTERVALS
100.5	CONTOURS - MINOR INTERVALS
x 100.00	EXISTING GROUND ELEVATION
(100.00)	PROPOSED GROUND ELEVATION
(100.00)	EXISTING ROAD ELEVATION
(100.00)	PROPOSED ROAD ELEVATION



**jdb project engineering inc.**

1-880L - 15TH STREET WINKLER, MB R6W 0H5  
PH: (204) 331-4440 EMAIL: jbotha@jdbprojects.ca



05	TENDER	2023.03.21
04	REVISED DITCH PROFILE	2023.02.23
03	FINAL REVIEW	2022.08.10
02	REVISED DROP STRUCTURE	2022.08.09
01	REVIEW	2022.07.26
REVISION	ISSUED FOR	DATE

PROJECT: SOUTH RAILWAY DITCHING

TITLE: MISCELLANEOUS DETAILS

DESIGNED BY: NG	REVIEWED BY: JB	FIELD BOOK: NONE	SHEET NO: D01
DRAWN BY: NG	DATE: 2022.07.11	SCALE: AS SHOWN	DRAWING NO: 181

**CITY OF MORDEN**  
133 7TH STREET MORDEN, MB. R6M 1S3  
PHONE: (204) 922-2562

## Contents

GC1. DEFINITIONS .....	3
GC2. INTERPRETATION .....	5
GC3. DECLARATIONS .....	5
<i>Good Faith</i> .....	6
GC4. EXECUTION OF CONTRACT .....	6
GC5. AUTHORITY OF CONTRACT ADMINISTRATOR .....	6
<i>Contract</i> .....	6
<i>Inspection</i> .....	6
<i>Control</i> .....	6
GC6. RESPONSIBILITIES OF CONTRACTOR .....	7
<i>Contract</i> .....	8
<i>Laws and Regulations</i> .....	8
Patents and Royalties .....	8
<i>Personnel</i> .....	9
<i>Control</i> .....	9
<i>Subcontractors</i> .....	10
GC7. CHANGES IN WORK .....	10
<i>Valuation of a Change in Work</i> .....	11
<i>Cost Records</i> .....	12
GC8. RIGHT OF ENTRY .....	12
GC9. CONTROL OF PLANT AND MATERIAL .....	13
GC10. RISK AND RESPONSIBILITY .....	13
GC11. INSPECTION .....	13
<i>Defective Work</i> .....	14
GC12. MEASUREMENT AND PAYMENT .....	14
<i>Increased or Decreased Costs</i> .....	15
<i>Measurement and Payment</i> .....	15
<i>Final Payment</i> .....	15
GC13. WARRANTY .....	16
<i>Warranty Period</i> .....	16
<i>Warranty Inspection</i> .....	16
<i>Warranty Work</i> .....	17
<i>Acceptance of the Work</i> .....	17
GC14. GOVERNING LAW .....	17
GC15. ASSIGNMENT .....	17
GC16. FORCE MAJEURE .....	17
GC17. INDEMNITY .....	18



The City of Morden

GC18. EVENTS OF DEFAULT .....	18
GC19. CITY'S RIGHTS AND REMEDIES .....	19
<i>Withholding of Payment</i> .....	19
<i>Taking the Work out of the Contractor's Control</i> .....	20
<i>Demand for Payment</i> .....	20
<i>Terminating the contract</i> .....	21
GC20. SURETY'S OPTION TO ASSUME THE CONTRACT .....	21
GC21. CONTRACTOR'S RIGHT TO APPEAL .....	21
GC22. ARBITRATION .....	22
<i>Referral to a Single Arbitrator</i> .....	22
<i>Referral to a Panel of Arbitrators</i> .....	22
<i>General</i> .....	22
GC23. INSURANCE AND CONTRACT SECURITY .....	22
<i>INSURANCE</i> .....	23
<i>CONTRACT SECURITY</i> .....	24
GC 24 SCHEDULE OF WORK .....	24
GC25 DELAYS .....	25
GC26 LIQUIDATED DAMAGES .....	25
GC27 NOTICES .....	25

## GENERAL CONDITIONS FOR CONSTRUCTION CONTRACTS

### GC1. DEFINITIONS

GC1.1 Where used in these General Conditions and in the other documents forming part of the Contract:

- (a) **“Addenda”** means any supplemental written specifications, instructions, or drawings issued prior to the execution of the Agreement, modifying or interpreting the Contract Documents.
- (b) **“Agreement”** means the agreement set out in Section 2.
- (c) **“Award Authority”** means the authority having the jurisdiction to award the Contract according to the City’s by-laws, policies or procedures;
- (d) **“Bid”** means the documents and other things, including but not limited to forms contained in the Bid Submission, which must be completed or provided and submitted by the Submission Deadline in order to constitute a responsive offer;
- (e) **“Bid Opportunity”** means the Bid Submission, the Bidding Procedures, these General Conditions, the Supplemental Conditions, the Specifications, the Drawings and all addenda;
- (f) **“Bid Submission”** means that portion of the Bid Opportunity by that name which contains forms to be included in the Bid;
- (g) **“Bidder”** means any person submitting a Bid for the Work;
- (h) **“Bidding Procedures”** means the portion of the Bid Opportunity by that name which sets out the terms and conditions governing the Bid, and a reference to a section, clause or subclause with the prefix **“B”** designates a section, clause or subclause in that portion of the Bid Opportunity;
- (i) **“Business Day”** means any Calendar Day, other than a Saturday, Sunday, or a statutory or civic holiday;
- (j) **“C”** designates a section, clause or subclause in these General Conditions;
- (k) **“Calendar Day”** means the period from one midnight to the following midnight;
- (l) **“Change in Work/Change Order”** means an addition, deletion or modification to the Work as described in the Contract at the time that the Contract is awarded and includes modifications in quantity or nature of Plant, Material or labour, methods, location or work schedule;
- (m) **“Chief Administrative Officer”** means the City employee holding that office or, if applicable, the successor to the authority or responsibility of such office;
- (n) **“City”** means The City of Morden and ;
- (o) **“City Solicitor”** means the City employee holding that office or, if applicable, the successor to the authority or responsibility of such office;
- (p) **“Contract”** means the combined documents consisting of the agreement prepared and forwarded to the Contractor pursuant to C4 and all schedules thereto (consisting of the Bid Opportunity, and any documents and Drawings referred to and incorporated therein) together with any submissions required to be made by the Contractor after award, and all amendments to the foregoing;
- (q) **“Contract Administrator”** means the person designated as such in the Supplemental Conditions. The words Contract Administrator and Engineer are interchangeable
- (r) **“Contract Price”** means the price agreed upon for the Work and any adjustments thereto which may be required or agreed to pursuant to the Contract;
- (s) **“Contractor”** means the person undertaking the performance of the Work under the terms of the Contract;
- (t) **“Council”** means the Council of The City of Morden;
- (u) **“Drawings”** means drawings which show the nature and scope of the Work to be performed and which have been prepared or approved by the Contract Administrator and are referred to in the Contract;
- (v) **“Engineer”** means and includes the Engineer of the City and any other person duly authorized to act as Engineer or to represent the Engineer on behalf of the City. The term Engineer and Contract administrator used in this document is interchangeable.

The City of Morden

- (w) **“Manager of Materials”** means the City employee holding that office or, if applicable, the successor to the authority or responsibility of such office;
- (x) **“Material”** means any things, including goods, parts and equipment, which are to form part of the permanent Work;
- (y) **“may”** indicates an allowable action or feature which will not be evaluated;
- (z) **“must”** or **“shall”** indicates a mandatory requirement which will be evaluated on a pass/fail basis;
- (aa) **“Owner”** Owner means City of Morden.
- (bb) **“Person”** means an individual, firm, partnership, association or corporation, or any combination thereof, and includes heirs, administrators, executors or legal representatives of a person;
- (cc) **“Plant”** means any things brought to or constructed upon the Site by the Contractor for the performance of the Work, including goods, tools, equipment, consumable supplies, fuel, power and utility connections therefor, but does not include Material;
- (dd) **“Shop Drawings”** means all drawings, diagrams, illustrations, schedules, performance charts, brochures and other data which are prepared by the Contractor, Subcontractor, manufacturer, supplier or distributor and which illustrate some portion of the Work;
- (ee) **“should”** indicates a desirable action or feature which will be evaluated on a relative scale; (bb) **“Site”** means the lands and other places, including structures, on, under, in or through which the Work is to be performed;
- (ff) **“Specifications”** means the portion of the Bid Opportunity by that name which sets out the written description of the physical or functional characteristics of the Work, or any part thereof, including without limitation any requirement for testing or inspection, and a reference to a section, clause or subclause with the prefix **“E”** designates a section, clause or subclause in that portion of the Bid Opportunity;
- (gg) **“Subcontractor”** means a person contracting with the Contractor for the performance of a part or parts of the Work or for the furnishing of Plant or Material and includes a Subcontractor’s subcontractor;
- (hh) **“Submission Deadline”** means the time and date set out in the Bidding Procedures for final receipt of Bids;
- (ii) **“Substantial Performance”** shall have the meaning attributed to it in The Builders' Liens Act (Manitoba), or any successor legislation thereto;
- (jj) **“Supplemental General Conditions”** means the portion of the Bid Opportunity by that name which sets out terms and conditions specific to the Contract, and supplements or modifies the General Conditions, and a reference to a section, clause or subclause with the prefix **“D”** designates a section, clause or subclause in that portion of the Bid Opportunity;
- (kk) **“Total Performance”** means that the entire Work, except those items arising from the provisions of GC13, have been performed in accordance with the Contract;
- (ll) **“Work”** means the carrying out and the doing of all things, whether of a temporary or permanent nature, that are to be done by the Contractor pursuant to the Contract and, without limiting the generality of the foregoing, includes the furnishing of all Plant, Material, labour and services necessary for or incidental to the fulfilment of the requirements of the Contract, including all Changes in Work which may be ordered as herein provided
- (mm) **“Working Day”** means any Calendar Day, other than a Saturday, Sunday, or a statutory or civic holiday, on which the Contract Administrator determines atmospheric and Site conditions are such that the Contractor is able to work at least seven (7) hours during the period between 7:00 a.m. Morden time or the time the Contractor's operations normally commence, whichever is the earlier, and 7:00 p.m. Morden time.

## **GC2. INTERPRETATION**

- GC2.1 Where the Contractor consists of more than one person, the obligations of the Contractor shall be joint and several.
- GC2.2 Wherever the singular or masculine is used, it shall be construed to mean the plural or the feminine or the neuter as the context may reasonably require.
- GC2.3 Headings, titles and margin notes in the Contract are inserted for convenience only and shall not be considered in any construction or interpretation of the Contract.
- GC2.4 In the event of conflicts between portions of the Contract, the following shall apply:
- (a) the executed agreement between the City and Contractor shall govern over all schedules or other documents forming part of the Contract;
  - (b) the Supplemental General Conditions shall govern over the General Conditions;
  - (c) the General Conditions shall govern over Specifications;
  - (d) Specifications of a later date shall govern over Specifications of an earlier date;
  - (e) Specifications shall govern over Drawings;
  - (f) Drawings of a later date shall govern over Drawings of an earlier date;
  - (g) Drawings of larger scale shall govern over those of smaller scale;
  - (h) figured dimensions shown on a Drawing shall govern over scaled or implied dimensions on the same Drawing; and
  - (i) Drawings shall govern over the Bid.
- GC2.5 The various portions of the Contract are intended to be read together and complement each other, and what is called for by any one shall be deemed to be called for by all.
- GC2.6 The City and the Contractor acknowledge and agree that the Contractor is an independent contractor and neither the Contractor, nor any officer, servant or agent of the Contractor, shall be deemed to be an employee, agent, representative or servant of the City.
- GC2.7 The Contract shall constitute the entire agreement between the City and the Contractor. There are no representations, warranties, covenants or agreements other than those contained in the Contract.

## **GC3. DECLARATIONS**

### *Site Investigation*

- GC3.1 The Contractor declares that, in bidding for the Work and in entering into the Contract, he:
- (a) has investigated the Site, the nature of the Work to be done and all local conditions that might affect his Bid or his performance of the Work, including:
    - (i) the location of any utility which can be determined from the records or other information available at the offices of any public authority or person, including a municipal corporation and any board or commission thereof, having jurisdiction or control over the utility;
    - (ii) the nature of the surface and subsurface conditions at the Site;
    - (iii) the location, nature, quality or quantity of the materials to be removed or to be employed in the performance of the Work;
    - (iv) the nature, quality or quantity of the Plant needed to perform the Work;
    - (v) all matters concerning access to the Site, power supplies, location of existing services, utilities or materials necessary for the completion of the Work; and

The City of Morden

- (vi) all other matters which could in any way affect the performance of the Work; or
  - (b) has not investigated the Site, the nature of the Work to be done or local conditions;
- and, in either event, assumes all risk for conditions now existing or arising in the course of the Work which have been or could have been determined through such investigation, and that he did not and does not rely upon information furnished by the City or any of its servants or agents other than information furnished in writing for or in connection with the Bid or the Contract by the Contract Administrator.

**Good Faith**

- GC3.2 The Contractor declares that, in bidding for the Work and in entering into the Contract, he:
- (a) does so in good faith and that to the best of his knowledge no member of Council or any officer or employee of the City has any pecuniary interest, direct or indirect, in the Contract which has not been disclosed to and approved by the authority having jurisdiction;
  - (b) has not participated in any collusive scheme or combine;
  - (c) shall forfeit all claims under the Contract as well as refund to the City any monies paid to him, beyond his actual proven expenses for Work done, if GC3.2(a) or (b) are shown to be false.

**GC4. EXECUTION OF CONTRACT**

- GC4.1 The Contractor shall execute the Contract in the manner stipulated by the City and return the Contract, within seven (7) Calendar Days of receipt of the Contract, to the City at the address indicated in the Supplemental Conditions.
- GC4.2 If the Contractor does not execute and return the Contract as set out in GC4.1, the Contractor may be deemed by the City to have abandoned the Contract, whereupon the acceptance of the offer by the City shall be null and void, and the City shall be entitled to retain the bid security accompanying the Bid as liquidated damages.
- GC4.3 No payments will be made by the City to the Contractor until the Contractor has executed and returned the Contract as set out in GC4.1.

**GC5. AUTHORITY OF CONTRACT ADMINISTRATOR**

*General*

- GC5.1 The Contract Administrator shall be the City's representative throughout the duration of the Contract and shall have authority to act on behalf of the City to the extent expressly provided for in the Contract.

**Contract**

- GC5.2 The Contract Administrator shall interpret or clarify the Contract or any part thereof which appears indefinite, not clear or contradictory to the Contractor.
- GC5.3 The Contract Administrator may at any time correct errors or omissions in the Contract or issue additional Drawings or Specifications further detailing, explaining or modifying the Work. Such Drawings or Specifications shall either supplement or supersede those forming part of the Contract at the time the Contract was executed.

**Inspection**

- GC5.4 The Contract Administrator may examine or inspect the Work or any part thereof and determine whether the Work meets the requirements of the Contract. The Contract Administrator may reject the Work or any part thereof which does not meet the requirements of the Contract.

**Control**

The City of Morden

- GC5.5 The Contract Administrator may give instructions or orders to the Contractor to the extent necessary to ensure that the Work is performed in an orderly manner and meets the requirements of the Contract.
- GC5.5.1 The Contract Administrator may give instructions or orders to the Contractor's supervisor on the Site and such instructions or orders shall be deemed to have been given to the Contractor.
- GC5.6 The Contract Administrator may order the Contractor to remove from the Work any person employed or retained by the Contractor or a Subcontractor in the performance of the Work who the Contract Administrator determines is incompetent, negligent or guilty of misconduct.
- GC5.7 The Contract Administrator may order the Contractor to alter or improve his methods, to increase or improve his Plant, to furnish additional or more suitable Material, or to employ additional or more qualified labour if, at any time, the Contract Administrator determines that:
- (a) the Work is not being, or will likely not be, constructed satisfactorily; or
  - (b) progress is not being, or will likely not be, maintained in accordance with the work schedule.
- GC5.8 The Contract Administrator may order the Contractor to stop work or to take such remedial measures as the Contract Administrator considers necessary, if, at any time, the Contract Administrator determines that:
- (a) a danger to life or to property exists; or
  - (b) such stoppage or remedial measures may be necessary to ensure the performance of the Work in accordance with the requirements of the Contract.
- GC5.9 Neither the giving of any orders by the Contract Administrator nor the carrying out of such orders by the Contractor shall entitle the Contractor to any extra payment, nor relieve the Contractor of his responsibilities under GC6.
- GC5.10 The Contract Administrator shall determine if and when Substantial Performance and Total Performance are achieved and shall certify the dates thereof.
- GC5.11 If the Contractor disputes a determination or order of the Contract Administrator on any of the foregoing matters, the Contractor shall act in accordance with the Contract Administrator's determination or order. The Contractor may concurrently appeal the determination or order of the Contract Administrator to the Chief Administrative Officer as provided for in GC21.

## **GC6. RESPONSIBILITIES OF CONTRACTOR**

### *General*

- GC6.1 Except as otherwise provided in the Contract, the Contractor shall be solely responsible for construction means, methods, techniques, sequences and procedures, and for coordinating the various parts of the Work so as to ensure its proper completion in a sound and workmanlike manner, in all respects in strict conformity with the Contract and in accordance with the approved work schedule.
- GC6.2 The Contractor shall have complete control over the methods of performing the Work and shall direct and supervise the Work so as to ensure conformance with the Contract.
- GC6.3 The Contractor shall provide all Plant, Material, labour, services and incidentals necessary for the performance of the Work.
- GC6.4 The Contractor shall be responsible for any Work not explicitly set out in the Contract but which may be reasonably implied for the proper completion of the Work.
- GC6.5 Unless otherwise specified in the Specifications, all Material shall be new, fit for the purpose intended and shall meet or exceed the kind, quality and quantity of same specified in the Contract. If required,

The City of Morden

the Contractor shall provide evidence satisfactory to the Contract Administrator that the foregoing requirements have been met.

**Contract**

- GC6.6 The Contractor shall perform, complete and maintain the Work in strict accordance with the Contract.
- GC6.7 If the Contract or any part thereof appears indefinite, not clear or contradictory, the Contractor shall refer such feature or features to the Contract Administrator for interpretation or clarification.
- GC6.8 The Contractor shall obey, perform and comply with the Contract Administrator's orders, instructions, rules and procedures with respect to the Work or concerning the conduct thereof, promptly, efficiently and to the satisfaction of the Contract Administrator and he will assist other contractors, their employees and agents to do the same.
- GC6.9 The Contractor shall be responsible for conveying the interpretation or clarification of the Contract, as given by the Contract Administrator, to Subcontractors.
- GC6.10 The Contractor shall prepare and submit all drawings, schedules, documents or information required by the Contract and such other drawings, schedules, documents or information as may reasonably be required by the Contract Administrator.
- GC6.11 The Contractor shall keep one copy of the Contract and any other approved drawings, schedules, documents or other information at the Site, and shall make them available at all reasonable times for the inspection and use of the Contract Administrator.

**Laws and Regulations**

- GC6.12 The Contractor shall comply with all laws, by-laws, ordinances, regulations, codes and orders of authorities having jurisdiction which are or come into force during the performance of the Work and which relate to the Work. Where there are two or more laws, by-laws, ordinances, regulations or codes applicable to the Work, the most restrictive shall apply.
- GC6.13 The Contractor shall procure approvals, clearances, permits, licences and certificates required by law or by any by-laws, ordinances, regulations, codes or orders of the authorities having jurisdiction for the performance of the Work, but this shall not include the obtaining of permanent easements or rights of servitude.
- GC6.14 The Contractor shall give any notices required by law or by by-laws, ordinances, regulations, codes or orders of the authorities having jurisdiction and which relate to the Work.
- GC6.15 The Contractor shall be registered with the Workers Compensation Board of Manitoba, shall provide and maintain workers compensation coverage throughout the term of the Contract, and shall provide the Contract Administrator with evidence thereof upon request.
- GC6.16 The Contractor shall not be responsible for verifying that the Contract complies with the applicable laws, by-laws, ordinances, regulations, codes and orders relating to the Work.

**Patents and Royalties**

- GC6.17 If the Contract requires or the Contractor desires the use of any design, device, material or process covered by letters patent, copyright, trademark or trade name, the Contractor shall provide for such use by suitable legal agreement with the owner or licensee.
- GC6.17.1 Upon request of the Contract Administrator, the Contractor shall provide the City with a copy of the said agreement.
- GC6.18 If the City or the Contractor is served with a claim or notice of an infringement or alleged

The City of Morden

infringement of any patent, copyright, trademark or trade name, the party so served shall immediately give notice thereof to the other party.

- GC6.19 If the City or the Contractor is prevented by injunction from using any design, device, material or process covered by letters patent, copyright, trademark or trade name, the Contractor shall, at his own cost, substitute an equally suitable design, device, material or process, all subject to the prior approval of the Contract Administrator.

***Personnel***

- GC6.20 The Contractor shall provide competent, suitably qualified personnel to perform the Work. He shall at all times maintain good discipline and order at the Site.

- GC6.21 The Contractor shall employ and keep on the Work, at all times during the performance of the Work, a competent supervisor and assistants, if necessary, acceptable to the Contract Administrator. The supervisor shall represent the Contractor on the Site. The supervisor shall not be replaced without the prior consent of the Contract Administrator unless the supervisor proves to be unsatisfactory to the Contractor and ceases to be in his employ.

- GC6.22 If the Contract Administrator orders a person to be removed from the Work, the Contractor shall comply forthwith. Any person so removed shall not be re-employed on the Work by the Contractor or by a Subcontractor.

***Control***

- GC6.23 The Contractor must arrange and carry on his Work so as not to conflict with the Work being carried on or to be carried on for the City by other contractors or by the City's employees. If the Contractor finds it difficult to work in harmony with such parties, he shall notify the Contract Administrator promptly.

- GC6.24 The Contractor shall be solely responsible for construction safety at the Site and for compliance with all laws, rules, regulations and practices required by the applicable construction and safety legislation.

- GC6.25 The Contractor shall be solely responsible for securing the Site, and any existing facility thereon, and for the proper care and protection of the Work already performed.

- GC6.26 The Contractor shall do whatever is necessary to ensure that:

- (a) no person, property, right, easement or privilege is injured, damaged or infringed by reason of the Contractor's activities in performing the Work;
- (b) pedestrian and other traffic on any public or private road or waterway is not unduly impeded, interrupted or endangered by the performance or existence of the Work or Plant;
- (c) fire hazards in or about the Work or its Site are eliminated;
- (d) the health and safety of all persons employed in the performance of the Work or otherwise is not endangered by the method or means of its performance;
- (e) adequate medical services are available to all persons employed on the Work or its Site at all times during the performance of the Work;
- (f) adequate sanitation measures are taken and facilities provided with respect to the Work and its Site;
- (g) all survey posts, buoys or control monuments are protected and are not removed, defaced, altered or destroyed; and
- (h) all stakes, buoys and marks placed on the Work or its Site by or under the authority of the Contract Administrator are protected and are not removed, defaced, altered or destroyed.

- GC6.27 The Contractor shall maintain the Site and the Work in a tidy condition and free from the accumulation of waste and debris, other than that caused by the City or by other contractors.



The City of Morden

- GC6.27.1 Upon attaining Substantial Performance, the Contractor shall remove any Plant and Material not required for the performance of the remaining Work. He shall also remove waste and debris other than that caused by the City or other contractors, and leave the Site and the Work clean and suitable for occupancy by the City unless otherwise specified.
- GC6.27.2 Total Performance shall not be considered to have been achieved until the Contractor has cleaned up the Site and has removed all Plant, surplus Material, waste and debris, other than that left by the City or other contractors.
- GC6.28 The Contractor shall perform the Work so as to progress continuously with the Work or any part thereof and in such a manner as to ensure the proper completion of the Work or any part thereof, within the time stipulated.

***Subcontractors***

- GC6.29 The Contractor shall not employ any Subcontractor to whom the Contract Administrator may reasonably object.
- GC6.29.1 The Contractor agrees that the Subcontractors identified in his Bid, or in any subsequent submission, are the Subcontractors to be used to carry out those parts of the Work noted therein.
- GC6.29.2 The Contractor shall not add, remove or replace any Subcontractor, or change the part of the Work to be performed by a Subcontractor, without the prior approval of the Contract Administrator.
- GC6.30 The Contractor, with respect to Work to be performed under subcontract, shall:
- (a) enter into contracts or written agreements with his Subcontractors to require them to perform their work in complete conformance with and subject to the terms and conditions of the Contract; and
  - (b) be as fully responsible to the City for acts and omissions of his Subcontractors and of persons directly or indirectly employed by them as for acts and omissions of persons directly employed by him.
- GC6.31 The Contractor shall incorporate the terms and conditions of the Contract into all subcontract agreements he enters into with his Subcontractors.
- GC6.32 The Contractor shall make prompt payment to his Subcontractors, his employees or on account of the purchase or rental of Plant or Material.
- GC6.33 The Contractor shall promptly secure a discharge of a lien or trust claim served upon the City pursuant to The Builders' Liens Act (Manitoba).

**GC7. CHANGES IN WORK**

*General*

- GC7.1 The City shall have the right to order a Change in Work at any time after award of the Contract. GC7.2 If, at any time after award of the Contract, the Contractor is of the opinion that a Change in Work is necessary to accomplish the result intended by the Contract or if the Contractor considers it desirable that a Change in Work be approved, he shall promptly provide notice thereof to the Contract Administrator, including:
- (a) the reason for the proposed Change in Work;
  - (b) a detailed description of the proposed Change in Work;
  - (c) the Contractor's proposed method(s) to determine the adjustment, if any, in Contract Price pursuant to GC7.4.
- GC7.2.1 Without limiting the generality of GC7.2, if the Contractor observes:
- (a) any substantial difference in the nature of the surface or subsurface conditions at the Site, or

The City of Morden

the location, nature, quality or quantity of the materials to be removed, from those set out in the Contract; or

- (b) that the Contract is at variance with any laws, ordinances, rules, regulations or codes of authorities having jurisdiction, or if changes are made to any laws, ordinances, rules, regulations and codes subsequent to the Submission Deadline which require modifications to the Contract;

the Contractor shall immediately notify the Contract Administrator.

- GC7.3 The Contract Administrator shall determine whether a Change in Work is necessary or desirable and whether a corresponding adjustment to the Contract Price is required.
- GC7.3.1 If the Contract Administrator determines that no Change in Work is necessary or desirable, he will issue a notice stating his determination.
- GC7.3.2 If the Contract Administrator determines that a Change in Work is necessary or desirable but no corresponding adjustment to the Contract Price is required, he will issue a notice approving the Change in Work and stating his determination.
- GC7.3.3 If the Contract Administrator determines that a Change in Work is necessary or desirable, which requires a corresponding adjustment to the Contract Price, and he is able to determine such adjustment based on the available information, he shall issue a notice approving the Change in Work and stating his determination regarding the method(s) to be used to determine the adjustment in Contract Price pursuant to GC7.4.
- GC7.3.4 If the Contract Administrator determines that a Change in Work is necessary or desirable, which requires a corresponding adjustment to the Contract Price, and he requires further information to determine such adjustment, he shall issue a notice stating his determination and requiring the Contractor to submit the Contractor's proposed method(s) to determine the adjustment in Contract Price pursuant to GC7.4, and upon receipt and evaluation of such information, he shall issue a notice in accordance with GC7.3.3.

***Valuation of a Change in Work***

- GC7.4 The adjustment in Contract Price resulting from a Change in Work shall be determined by one or more of the following methods:
  - (a) by estimate in a lump sum;
  - (b) by the unit prices and methods of measurement set out in the Contract or subsequently agreed upon;
  - (c) by the actual cost of the Change in Work to the Contractor plus a fixed fee;
  - (d) by the actual cost of the Change in Work to the Contractor plus fifteen percent (15%) on any portion of the Change in Work undertaken by the Contractor's own forces or plus ten percent (10%) on any portion of the Change in Work undertaken by a Subcontractor.
- GC7.4.1 For the purposes of GC7.4(c) or (d), "actual cost" on any portion of the Change in Work undertaken by the Contractor's own forces shall mean the direct cost of labour plus an allowance for direct supervision and payroll burden (including Employment Insurance, Canada Pension, Payroll Tax, Workers Compensation assessments and vacation pay), purchase or rental of Plant and Material and any other payments made by the Contractor with the prior approval of the Contract Administrator that are necessary for the performance of the Change in Work.
- GC7.4.2 For the purposes of GC7.4(c) or (d), "actual cost" on any portion of the Change in Work undertaken by a Subcontractor shall mean the amount invoiced by the Subcontractor and paid by the Contractor, net of any discounts and excluding any late payment interest or penalties.
- GC7.5 If a Change in Work results in a reduction in the Contract Price, no claim may be made for damages on the ground of loss of anticipated profit on Work so diminished or on any other ground provided that the

The City of Morden

aggregate reduction in the Contract Price does not exceed twenty percent (20%) of the price agreed upon for the Work as of the date of the award of the Contract.

- GC7.5.1 Reductions in the Contract Price as a result of:
- (a) Changes in Work requested by the Contractor;
  - (b) a deduction, pursuant to GC11.7(d), for defective or deficient Work;
  - (c) a decrease, pursuant to GC12.4, due to a change in tax; or
  - (d) the City's application of a remedy for an event of default;
- shall not be considered in calculating the aggregate reduction in the Contract Price for the purposes of GC7.5.
- GC7.6 If a Change in Work diminishes the Work, or any part thereof, resulting in:
- (a) extra cost to the Contractor, directly attributable to the diminution, for which he would not be entitled to payment on a unit price basis (e.g., loss of volume discounts); or
  - (b) loss to the Contractor in respect of Material required by the City to be purchased by him for the Work but not used thereon as a direct result of the diminution (e.g., restocking charges);
- the Contractor shall be compensated therefor by the City in the sum or sums determined by the Contract Administrator.
- GC7.7 If the method of valuation or measurement or the adjustment to the Contract Price cannot be promptly agreed upon and the Contract Administrator requires the Change in Work to proceed, then the Contract Administrator will determine the method of valuation and measurement and the adjustment to the Contract Price. The Contract Administrator shall issue a notice approving the Change in Work and setting out the method of valuation, measurement, and any approved adjustments to the Contract Price.
- GC7.8 If the Contractor disputes a determination made by the Contract Administrator, the Contractor shall act in accordance with the Contract Administrator's determination. The Contractor may concurrently appeal the determination of the Contract Administrator to the Chief Administrative Officer as provided for in GC21.

#### **Cost Records**

- GC7.9 If a valuation is required pursuant to GC7.4 or GC7.6, the Contractor shall provide the Contract Administrator with:
- (a) detailed and accurate statements showing:
    - (i) description, cost (including expenses for operation and maintenance) and time for Plant used by the Contractor;
    - (ii) description, cost and quantity for Material used by the Contractor;
    - (iii) rate of pay and hours of work for each of the persons employed by the Contractor; and
  - (b) access to any cost records (including payroll records, time books and invoices) or other data necessary to verify the accuracy of such statements.

#### **GC8. RIGHT OF ENTRY**

- GC8.1 The Contractor shall not be entitled to exclusive possession of the Site.
- GC8.2 The City shall have the right, for itself, its agents, representatives or other persons, to enter, occupy or use any portion of the Site or the Work, at any time and for so long a time as the Contract Administrator may require.
- GC8.3 Such entry, occupation or use shall not constitute acceptance of the Work by the City nor shall it relieve the Contractor of responsibility to complete the Work.

**GC9. CONTROL OF PLANT AND MATERIAL**

- GC9.1 The Contractor shall not remove any Plant or Material that he has brought to the Site and which is required to complete the Work without the prior consent of the Contract Administrator until the date of Total Performance.
- GC9.2 Plant or Material that is the property of the City shall not be removed from the Site, disposed of or used except for the purposes of the Work without the prior consent of the Contract Administrator.
- GC9.3 The Contractor shall keep such records of all Plant and Material supplied or placed in the care, custody and control of the Contractor by the City as the Contract Administrator may from time to time require and shall satisfy the Contract Administrator, when requested, that such Plant and Material are at the place and in the condition required by the City.

**GC10. RISK AND RESPONSIBILITY**

- GC10.1 Plant or Material brought to the Site or the Work by the Contractor shall remain at the risk and the responsibility of the Contractor from the commencement of the Work until:
- (a) Material is incorporated into the Work; or
  - (b) Plant or Material is removed from the Site or the Work by the Contractor.
- GC10.2 The Contractor shall be liable to the City for any loss of or damage to Plant or Material that is supplied to or placed in the care, custody and control of the Contractor by the City in connection with the Contract, whether or not that loss or damage is attributable to causes beyond the Contractor's control, from the commencement of the Work until:
- (a) Material is incorporated into the Work; or
  - (b) Plant or Material is returned, in its original condition, to the City.
- GC10.3 The Work shall remain at the risk and the responsibility of the Contractor from the commencement of the Work until the date of Substantial Performance.
- GC10.4 That portion of the Work not completed as of the date of Substantial Performance shall remain at the risk and responsibility of the Contractor until the date of Total Performance.
- GC10.5 The Contractor shall, at his own cost, be required to maintain the Work, make good all damage thereto and imperfections therein and to deliver the completed Work to the City in accordance with the provisions of the Contract.

**GC11. INSPECTION**

*General*

- GC11.1 The Contractor shall provide the Contract Administrator access, whether at the Site or at the premises of the Contractor or any Subcontractor, to observe and inspect the Work and its progress.
- GC11.2 The Contractor shall provide the Contract Administrator any samples required to inspect the Work.
- GC11.3 The Contractor shall provide the Contract Administrator any and all assistance which he may require to observe and inspect the Work.
- GC11.4 Before beginning or resuming operations upon any portion of the Work, the Contractor shall notify the Contract Administrator so as to enable him to arrange for inspection. If the Contractor fails to notify the Contract Administrator, the Contractor shall, if and when required by the Contract Administrator, forthwith take down or expose and rebuild that portion of the Work required to facilitate inspection. The cost of such taking down or exposure, and rebuilding, if any, shall be borne by the Contractor.

The City of Morden

- GC11.5 If and when required by the Contract Administrator, the Contractor shall take down or expose forthwith any portion of the Work where the Contract Administrator determines that the Work is not in accordance with the Contract. The cost of such taking down or exposure, and rebuilding, if any, shall fall upon the City if the taking down or exposure indicates that the portion exposed is properly constructed and of satisfactory Material, but if otherwise the cost shall be borne by the Contractor.
- GC11.6 The inspection herein provided for shall in no way relieve the Contractor of full responsibility for the quality, proper operation and performance of the Work.

***Defective Work***

- GC11.7 If the Contract Administrator determines that the Work, or any part thereof, is defective or deficient, the City shall have the right to do any one or more of the following in addition to anything permitted elsewhere in the Contract or by law:
- (a) if the Contract Administrator determines that any Plant is defective, deficient or otherwise unfit for the purpose intended, the Contract Administrator may direct the Contractor to remove such Plant from the Site and promptly replace it with Plant which meets the requirements of the Contract and is fit for the purpose intended;
  - (b) if the Contract Administrator determines that any Material which is not yet incorporated into the Work is defective, deficient or otherwise unfit for the purpose intended, the Contract Administrator may direct the Contractor to remove such Material from the Site and promptly replace it with Material which meets the requirements of the Contract and is fit for the purpose intended;
  - (c) if the Contract Administrator determines that the Work or any portion thereof, including any Material which is incorporated therein, is defective, deficient or otherwise unfit for the purpose intended, the Contract Administrator may direct the Contractor to repair, rebuild, replace or otherwise remedy the defect or deficiency;
  - (d) if the Contract Administrator determines that it is not expedient to correct defective or deficient Work, the City may deduct from the Contract Price the difference between the value of the Work as done and that called for by the Contract, the amount of which shall be determined by the Contract Administrator.
- GC11.8 The Contractor shall, without delay, carry out the directives of the Contract Administrator pursuant to GC11.7. In addition, the Contractor shall be responsible for the cost of any additional inspections necessitated thereby.
- GC11.9 The City shall be entitled, in its sole discretion, to use the Work or any portion thereof notwithstanding that it may be defective or deficient, and such use shall not constitute acceptance of any defects or deficiencies nor shall it relieve the Contractor of responsibility to complete the Work.

**GC12. MEASUREMENT AND PAYMENT**

*General*

- GC12.1 Unless otherwise specified in the Supplemental Conditions, the City shall only be required to pay the Contractor for Material required for the Work upon the installation and total incorporation of same permanently in the Work.
- GC12.2 The amounts to be paid by the City to the Contractor shall be the sums certified by the Contract Administrator in the interim and final progress estimates.
- GC12.2.1 For unit price Contracts, such sums shall be determined by the Contract Administrator upon the basis of the unit prices for the various classes of the Work stated on Form B: Prices. The total amount to be paid to the Contractor for the Work will be the amount arrived at by measuring the amount of each class of the Work listed on Form B: Prices and performed in accordance with the Contract, and pricing the same, in accordance with the unit prices stated thereon.

The City of Morden

- GC12.2.2 For lump sum Contracts, such sums shall be determined by the Contract Administrator upon the basis of the lump sum price stated on Form B: Prices.
- GC12.2.3 Prices stated on Form B: Prices shall be deemed to include:
- (a) duty;
  - (b) freight and cartage;
  - (c) Federal and Provincial taxes [except the Goods and Services Tax (GST), which shall be extra where applicable] and all charges governmental or otherwise paid;
  - (d) profit and all compensation which shall be due to the Contractor for the Work and all details necessarily connected with the completion of the Work and all risks and contingencies connected therewith.

***Increased or Decreased Costs***

- GC12.3 The Contract Price shall not be increased or decreased by reason of any increase or decrease in the cost of the Work to the Contractor except as provided for herein.
- GC12.4 The Contract Price shall be adjusted if any change in a tax imposed under the Excise Act, the Excise Tax Act, the Customs Act, the Customs Tariff, The Mining Tax Act (Manitoba), or The Retail Sales Tax Act (Manitoba):
- (a) occurs after the Submission Deadline;
  - (b) applies to Material; and
  - (c) affects the cost of that Material to the Contractor.
- GC12.5 If a change referred to in GC12.4 occurs, the Contract Price shall be increased or decreased by an amount equal to the amount that is established, by an examination of the relevant records of the Contractor, to be the increase or decrease in the cost incurred that is directly attributable to that change.
- GC12.6 For the purpose of GC12.4, where a tax is changed after the Submission Deadline but public notice of the change has been given by either the Federal or Provincial Minister of Finance before that date, the change shall be deemed to have occurred before the Submission Deadline and the Contractor shall not be entitled to an increase in the Contract Price.

***Measurement and Payment***

- GC12.7 By the fourteenth (14) Calendar Day after the end of each month, or as soon thereafter as possible, the Contract Administrator shall, subject to having received all necessary information from the Contractor by the seventh (7) Calendar Day after the end of that month, prepare a progress estimate setting out the quantity and value of the Work performed during the preceding month.
- GC12.8 The Contractor shall sign each progress estimate signifying that he agrees with the Contract Administrator's estimate of the quantity and value of the Work completed.
- GC12.9 Approval by the City of payment on account of a progress estimate will make the amount of the progress estimate valid for payment.
- GC12.10 Any payment made by the City to the Contractor on account of a progress estimate shall be less any holdback required to be made by The Builders' Liens Act, and such holdbacks or other amounts which the City is entitled to withhold pursuant to the Contract.

***Final Payment***

- GC12.11 Approval by the City of payment on account of the final progress estimate shall be subject to the following conditions:
- (a) issuance by the Contract Administrator of a certificate of Total Performance;

The City of Morden

(b) receipt by the City of a certificate from the Workers Compensation Board stating that full payment has been made to the Board with respect to all assessments owing.

GC12.12 Payment on account of the final progress estimate, including the holdback made by the City pursuant to The Builders' Liens Act, shall be paid to the Contractor when the time for filing liens or trust claims has elapsed, unless the City is in receipt of a lien or trust claim.

GC12.13 Neither the issuance of a certificate of Total Performance nor the payment of the final progress estimate shall relieve the Contractor from his responsibilities either under C13 or as a result of any breach of the Contract by the Contractor including, but not limited to, defective or deficient Work appearing after Total Performance, nor shall it conclude or prejudice any of the powers of the Contract Administrator or the Chief Administrative Officer hereunder.

GC12.14 Subject to GC12.15, acceptance by the Contractor of payment on account of the final progress estimate shall constitute a waiver and release by him of all claims against the City whether for payment for Work done, damages or otherwise arising out of the Contract.

GC12.15 If the Contractor disputes a determination made by the Contract Administrator with respect to an interim or final progress estimate, the Contractor shall be paid in accordance with the Contract

Administrator's determination. The Contractor may concurrently appeal the determination of the Contract Administrator to the Chief Administrative Officer as provided for in GC21.

### **GC13. WARRANTY**

#### *General*

GC13.1 The Contractor warrants that the Work will be free of any and all defects or deficiencies during the warranty period.

#### *Warranty Period*

GC13.2 Unless specifically stated otherwise in the Supplemental Conditions, the warranty period shall begin on the date of Total Performance and shall expire one (1) year thereafter unless extended pursuant to GC13.2.1 or GC13.2.2, in which case it shall expire when provided for under these sections.

GC13.2.1 If a defect or deficiency prevents the full and normal use or operation of the Work or any portion thereof, for purposes of calculating the warranty period, time shall be deemed to cease to elapse for the defective or deficient portion, and for any portion of the Work whose use or operation is prevented by such defect or deficiency, as of the date on which the defect or deficiency is observed or the use or operation is prevented and shall begin to run again when the defect or deficiency has been corrected or the Work may be used or operated to the satisfaction of the Contract Administrator.

GC13.2.2 If all outstanding defects or deficiencies have not been corrected to the satisfaction of the Contract Administrator by at least two (2) weeks prior to the date on which the warranty would expire except for this GC13.2.2, then the Contract Administrator may require the Contractor to extend the warranty period for a further period of one (1) year for those defects or deficiencies in the Work identified by the Contract Administrator as still outstanding and uncorrected or for any portion of the Work whose use or operation is prevented by such defects or deficiencies.

GC13.3 Notwithstanding GC13.2, if any law of Manitoba or of the jurisdiction in which the Work was manufactured requires, or if the manufacturer provides, a longer warranty period or a warranty which is more extensive in its nature, then the provisions of such law or manufacturer's warranty shall apply.

#### *Warranty Inspection*

GC13.4 Within a reasonable time before the warranty expires, the Contract Administrator shall request that the Contractor arrange, attend at and assist the Contract Administrator in carrying out an inspection of the

The City of Morden

Work.

GC13.5 Where the warranty period has been extended pursuant to GC13.2.2, a second inspection shall be carried out in accordance with GC13.4 before the warranty period, as extended, expires.

***Warranty Work***

GC13.6 The Contract Administrator shall notify the Contractor of observed defects or deficiencies and damage, if any, arising or resulting from such defects or deficiencies, within the warranty period.

GC13.7 The Contractor shall correct, to the satisfaction of the Contract Administrator, all defects, deficiencies and damage identified by the Contract Administrator in the manner and within the time period(s) specified in the notice.

GC13.8 If the Contractor disagrees with the Contract Administrator's determination under GC13.6, he shall nonetheless comply with GC13.7. The Contractor may concurrently appeal the determination of the Contract Administrator as provided for in GC21.

***Acceptance of the Work***

GC13.9 The Contract Administrator shall certify acceptance of the Work upon:

- (a) the satisfactory performance of the Work during the warranty period;
- (b) the Contractor having fully complied with GC13.7; and
- (c) the successful conclusion of any tests required under the Contract.

GC13.10 Only certification of acceptance of the Work shall constitute:

- (a) acceptance of the Work; or
- (b) acceptance that the Work or any part thereof has been duly performed; or
- (c) acceptance of the accuracy of any claim of the Contractor.

GC13.11 Certification of acceptance of the Work shall not, however, relieve the Contractor from his responsibilities for any breach of the Contract including, but not limited to, defective or deficient Work appearing after the date of such certification.

**GC14. GOVERNING LAW**

GC14.1 The Contract has been entered into in the Province of Manitoba and shall be governed by and construed and enforced in accordance with the laws of the Province of Manitoba and of Canada as applicable therein. The parties hereby irrevocably and unconditionally agree to the exclusive jurisdiction of the Courts in the Province of Manitoba and all courts competent to hear appeals therefrom.

**GC15. ASSIGNMENT**

GC15.1 The Contractor shall not assign the Contract or any payments thereunder without the prior consent of the City.

GC15.2 The Contract shall inure to the benefit of and be binding on the respective heirs, executors, administrators, successors and assigns of the City and the Contractor.

**GC16. FORCE MAJEURE**

GC16.1 If the Contractor is delayed in the performance of the Work by reason of strikes, lock-outs (including lock-outs decreed for its members by a recognized contractors' association of which the Contractor is a member), an act of God, or any other cause which the Contractor satisfies the Contract Administrator to



The City of Morden

be totally beyond his control, the work schedule shall be adjusted by a period of time equal to the time lost due to such delays.

- GC16.2 No extension for delay shall be approved unless a notice of the claim is received by the Contract Administrator from the Contractor within seven (7) Calendar Days of the date on which the cause of delay arose.
- GC16.3 Any delay or failure by the City to perform its obligations under this Contract shall be excused, to the extent that the delay or failure is caused by an event or occurrence beyond the reasonable control of the City and without its fault or negligence, such as by way of example and not by way of limitation, strikes, lock-outs, or acts of God, provided that written notice of the delay shall be given by the City within seven (7) Calendar Days of the date on which the cause of delay arose.
- GC16.4 Any notice or claim for extension must state the cause of delay and the length of extension requested.
- GC16.4.1 In the case of a continuing cause of delay, only one claim for an extension shall be necessary.

## **GC17. INDEMNITY**

- GC17.1 The Contractor shall save harmless and indemnify the City against all costs, damages or expenses arising from actions, claims, demands and proceedings, by whomsoever brought, made or taken as a result of acts or omissions of the Contractor, his Subcontractors, employees or agents in the performance or purported performance of the Work, and more particularly from:
- (a) accidental injury to or death of any person whether retained by or in the employ of the Contractor or not, arising directly or indirectly by reason of the performance of the Work, or by reason of any trespass on or damage to property;
  - (b) damage to any property owned in whole or in part by the City, or which the City by duty or custom is obliged, directly or indirectly, in any way or to any degree, to construct, repair or maintain;
  - (c) damage to, or trespass or encroachment upon, property owned by persons other than the City;
  - (d) any claim for lien or trust claim served upon the City pursuant to The Builders' Liens Act;
  - (e) failure to pay a Workers Compensation assessment, or Federal or Provincial taxes;
  - (f) unauthorized use of any design, device, material or process covered by letters patent, copyright, trademark or trade name in connection with the Work;
  - (g) inaccuracies in any information provided to the City by the Contractor.
- GC17.2 The City has the right, acting reasonably and upon notice to the Contractor, to settle any such action, proceeding, claim or demand and charge the Contractor with the amount so paid or to be paid in effecting a settlement.
- GC17.3 The Contractor shall pay to the City the value of all legal fees and disbursements required to settle any such claim or to defend the City against any such claim, action, proceeding, claim or demand notwithstanding that the settlement or defence of the said action, proceeding, claim or demand was undertaken on behalf of the City by a salaried employee of the City.
- GC17.4 If the Contractor fails to make any payment required to be made to the City pursuant to C17.2 and GC17.3, the City shall be entitled to deduct the amount of such payment from any payment required to be made by the City to the Contractor under the Contract or take whatever other remedies against the Contractor that the City may have at law.

## **GC18. EVENTS OF DEFAULT**

- GC18.1 An event of default will be deemed to have occurred if the Contractor:

The City of Morden

- (a) abandons the Work; or
- (b) is adjudged bankrupt or files for bankruptcy, becomes insolvent, makes a general assignment for the benefit of his creditors, or has a receiver or liquidator appointed in respect of his assets; or
- (c) is not performing or has not been performing the Work, or any part thereof, in a sound and workmanlike manner and in all respects in strict conformity with the Contract; or
- (d) is not progressing continuously with the Work or any part thereof, and in such a manner as to ensure the completion of the Work or any part thereof, in accordance with the work schedule; or
- (e) fails to take down, repair, rebuild, replace or otherwise remedy any defective or deficient Work, or to remove any defective or deficient Plant or Material; or
- (f) fails to remedy defects or deficiencies during the warranty period in the manner and within the time periods specified by the Contract Administrator; or
- (g) fails to make prompt payment to his Subcontractors, his employees or on account of the purchase or rental of Plant or Material; or
- (h) fails to promptly secure a discharge of a claim for lien or trust claim served upon the City pursuant to The Builders' Liens Act; or
- (i) fails to comply with any laws, by-laws or statutory regulations; or
- (j) fails to provide competent supervision at the Site; or
- (k) fails to submit any schedules, documents or information required by the Contract; or
- (l) refuses or neglects to comply with an order given by the Contract Administrator; or
- (m) commits any other breach of the Contract.

GC18.2 Any provision of the Contract may be waived only by express waiver in writing by the Contract Administrator. No express waiver of any provision shall imply the waiver of any other provision.

## **GC19. CITY'S RIGHTS AND REMEDIES**

### *General*

GC19.1 If an event of default has occurred, the City may do any one or more of the following:

- (a) withhold or retain the whole or part of any payment;
- (b) take the whole of the Work, or any part or parts thereof out of the hands of the Contractor;
- (c) demand payment for any amount owed to the City;
- (d) terminate the Contractor's right to continue with the Work in whole or in part or terminate the Contract.

all as more particularly set forth in GC19.3 to GC19.16 below.

GC19.2 The duties and obligations imposed upon the Contractor by the Contract and the rights and remedies available to the City hereunder shall be in addition to and not a limitation of any duties, obligations, rights and remedies otherwise imposed upon the Contractor or available to the City at law.

### ***Withholding of Payment***

GC19.3 If an event of default has occurred, the City may withhold or retain the whole or part of any payment to the Contractor.

GC19.4 The City may apply the amount withheld or retained to:

- (a) pay any person to whom the Contractor is indebted in respect of Material, labour or services furnished for the Work;
- (b) secure the discharge of a lien or trust claim served upon the City pursuant to The Builders' Liens Act;

The City of Morden

(c) indemnify, compensate or reimburse the City for amounts paid or costs incurred by the City in connection with the event of default.

GC19.5 Payment of such amounts shall discharge the City's liability to the Contractor to the same extent as payment directly to him.

GC19.6 Upon remedy of the event of default, any amount remaining from the amount withheld will be released to the Contractor.

***Taking the Work out of the Contractor's Control***

GC19.7 If an event of default has occurred, the City may, without process or action at law, upon giving the Contractor notice, take the whole of the Work, or any part or parts thereof out of the hands of the Contractor.

GC19.8 Upon such notice being given to the Contractor, he shall immediately discontinue the Work or any part or parts thereof specified in the said notice.

GC19.9 The taking of the Work or any part thereof out of the Contractor's control pursuant to GC19.7 shall not relieve or discharge the Contractor from any obligation under the Contract or imposed upon him by law except the obligation to complete the performance of that part of the Work that was taken out of the Contractor's control.

GC19.10 If the Work or any part thereof is taken out of the Contractor's control pursuant to GC19.7, all Plant and Material, and the interest of the Contractor in all licences, powers and privileges acquired, used or provided by the Contractor under the Contract shall be assigned by the Contractor to the City without compensation to the Contractor.

GC19.11 The City shall have the right, subject to GC20, to complete, by contract or with its own forces, the Work taken out of the Contractor's control, and the Contractor agrees that the City shall have the right to take possession of and use any of the Contractor's material and property of every kind provided by the Contractor for the purpose of the Work, and to procure other Plant or Material for the completion thereof. The City shall not be required to obtain the lowest price to complete the Work taken out of the Contractor's control.

GC19.12 When the Contract Administrator certifies that any Plant, Material or any interest of the Contractor referred to in GC19.10, is no longer required for the purposes of the Work, or that it is not in the best interest of the City to retain that Plant, Material or interest, it shall revert to the Contractor.

GC19.13 If the cost to the City of completing the Work or portion thereof as aforesaid is less than the amount to which the Contractor would have been entitled under the Contract for so doing, the Contractor shall have no claims in respect thereof against the City. If the cost of the Work performed by the City is more than the amount to which the Contractor would have been entitled under the Contract for the same Work, the City shall have a claim against the Contractor for such excess costs.

GC19.14 When any portion of the Work is being carried on by the City, by contract or otherwise, the Contractor shall continue to perform the remainder of the Work in accordance with the Contract, and in such manner as in no way to hinder or interfere with the persons performing the portion of the Work being carried on by the City.

***Demand for Payment***

GC19.15 If an event of default has occurred, the City may demand payment from the Contractor for amounts paid or costs incurred by the City in connection with the event of default.

GC19.16 The Contractor shall, within seven (7) Calendar Days of receipt of a notice from the City, pay the City the amount set out in the notice.

***Terminating the contract***

GC19.17 If the Owner terminates the Contractor's right to continue with the Work as provided in paragraphs GC19.1 (d) the Owner shall be entitled to:

- (d) take possession of the Work and Products delivered to the Place of the Work, subject to the rights of third parties, and finish the Work by whatever method the Owner may consider expedient, but without undue delay or expense, and
- (e) withhold further payment to the Contractor until a final certificate for payment is issued, and
- (f) charge the Contractor the amount by which the full cost of finishing the Work as certified by the Consultant, including compensation to the Consultant for the Consultant's additional services and a reasonable allowance as determined by the Consultant to cover the cost of corrections to work performed by the Contractor that may be required under GC13 - WARRANTY, exceeds the unpaid balance of the Contract Price; however, if such cost of finishing the Work is less than the unpaid balance of the Contract Price, the Owner shall pay the Contractor the difference, and
- (g) on expiry of the warranty period, charge the Contractor the amount by which the cost of corrections to the Contractor's work under C13 - WARRANTY exceeds the allowance provided for such corrections, or if the cost of such corrections is less than the allowance, pay the Contractor the difference.

**GC20. SURETY'S OPTION TO ASSUME THE CONTRACT**

- GC20.1 Where the City has given notice to the Contractor that the Work or part thereof has been taken out of the Contractor's control, the City shall promptly provide the Surety with a copy of such notice.
- GC20.2 The Surety may, at its option, assume the Contract in respect of the Work specified in the notice and proceed to perform same.
- GC20.3 Within fourteen (14) Calendar Days after the date on which the Surety is provided with a copy of the notice given to the Contractor, the Surety shall advise the City whether it intends to exercise such option. The said option shall expire if the Surety fails to so advise the City within the time specified.
- GC20.4 If the Surety has exercised its option in accordance with the foregoing, it shall take the Contractor's place in all respects. The Surety shall be bound by all terms and conditions of the Contract and shall be paid in accordance with the terms of the Contract for all Work performed by it.
- GC20.5 The Surety may, with the consent of the Chief Administrative Officer, subcontract the Work so taken over or any portion thereof.

**GC21. CONTRACTOR'S RIGHT TO APPEAL**

- GC21.1 If the Contractor disagrees with a determination or order of the Contract Administrator he may, within seven (7) Calendar Days after receiving notice of the Contract Administrator's determination or order, notify the Chief Administrative Officer of his contention with respect thereto and request a determination thereon from the Chief Administrative Officer.
- GC21.2 If the Contractor disagrees with the Chief Administrative Officer's determination he may request that the dispute be referred to arbitration in accordance with C22, by providing notice to the Chief Administrative Officer within seven (7) Calendar Days after receiving notice of the Chief Administrative Officer's determination.
- GC21.3 If the Contractor neglects or fails to observe fully and faithfully the above conditions, he shall be deemed to have accepted the Contract Administrator's determination and to have waived any said claim, at law or otherwise.

## **GC22. ARBITRATION**

### *Requests for Arbitration*

- GC22.1 If, at any time before the termination of the warranty period, any dispute, difference or question shall arise between the City and the Contractor regarding the Work, then every such dispute, difference or question may, with the consent of the Chief Administrative Officer, on behalf of the City, and the Contractor, be referred to arbitration. Notwithstanding that the parties may have consented to arbitration, no arbitration shall proceed before the date of Substantial Performance.
- GC22.2 The party desiring arbitration (the "Requesting Party") shall request the consent of the other party (the "Other Party") to refer a particular dispute, difference or question to arbitration.
- GC22.3 The Other Party shall reply to the request within seven (7) Calendar Days of receiving same.

### *Referral to a Single Arbitrator*

- GC22.4 If the Other Party has consented to arbitration, the Requesting Party shall nominate an arbitrator (the "Requesting Party's Nominee") within seven (7) Calendar Days of receiving the reply. The Other Party shall have seven (7) Calendar Days after receiving notice of the nomination to accept or reject the Requesting Party's Nominee.
- GC22.5 If the Other Party accepts the Requesting Party's Nominee, the dispute, difference or question shall be promptly referred to him or her.

### *Referral to a Panel of Arbitrators*

- GC22.6 If the Other Party rejects the Requesting Party's Nominee, it shall, within seven (7) Calendar Days of rejection, appoint its own arbitrator.
- GC22.7 The Requesting Party shall, within seven (7) Calendar Days of receiving the Other Party's rejection, appoint its own arbitrator.
- GC22.8 The arbitrators appointed under GC22.6 and GC22.7 shall, within seven (7) Calendar Days of the date on which the last of them was appointed, appoint a third arbitrator (the "Panel Chair") who will act as chair of the arbitration panel.

### *General*

- GC22.9 The Arbitration Act (Manitoba) or any successor legislation thereto shall apply to the arbitration in all respects except as expressly otherwise provided in these General Conditions.
- GC22.10 The single arbitrator or the Panel Chair, as the case may be, shall determine the procedure to be followed in the arbitration, which shall be consistent with The Arbitration Act (Manitoba) or any successor legislation thereto.
- GC22.11 Where the matter proceeds with a single arbitrator, each party shall be responsible for its own legal expenses, expenses to produce expert evidence or other expenses voluntarily incurred, and for an equal share of the fees and expenses of the single arbitrator and of any other expenses related to the arbitration.
- GC22.12 Where the matter proceeds with an arbitration panel, each party shall be responsible for its own legal expenses, expenses to produce expert evidence or other expenses voluntarily incurred, for the fees and expenses of the arbitrator appointed by it, and for an equal share of the fees and expenses of the Panel Chair and of any other expenses related to the arbitration.

## **GC23. INSURANCE AND CONTRACT SECURITY**

**INSURANCE**

Without restricting the generality of C17 - INDEMNITY, the Contractor shall provide, maintain, and pay for the insurance coverages specified in C23 - INSURANCE. Unless otherwise stipulated, the duration of each insurance policy shall be from the date of commencement of the Work until the date of the final certificate for payment. Prior to commencement of the Work and upon the placement, renewal, amendment, or extension of all or any part of the insurance, the Contractor shall promptly provide the Owner with confirmation of coverage and, if required, a certified true copy of the policies certified by an authorized representative of the insurer together with copies of any amending endorsements.

**GC23.1 General Liability Insurance:**

General liability insurance shall be in the joint names of the Contractor and the Owner with limits of not less than \$2,000,000 per occurrence and with a property damage deductible not exceeding \$2,500. To achieve the desired limit, umbrella, or excess liability insurance may be used. All liability coverage shall be maintained for completed operations hazards from the date of Substantial Performance of the Work, as set out in the certificate of Substantial Performance of the Work, on an ongoing basis for a period of 6 years following Substantial Performance of the Work. Where the Contractor maintains a single, blanket policy, the addition of the Owner and the Consultant is limited to liability arising out of the Work and all operations necessary or incidental thereto. The policy shall be endorsed to provide the Owner with not less than 30 days notice in writing in advance of any cancellation, and of change or amendment restricting coverage.

**GC23.2 Automobile Liability Insurance:**

Automobile liability insurance in respect of licensed vehicles shall have limits of not less than \$2,000,000 inclusive per occurrence for bodily injury, death, and damage to property, covering all licensed vehicles owned or leased by the Contractor, and endorsed to provide the Owner with not less than 15 days notice in writing in advance of any cancellation, change or amendment restricting coverage. Where the policy has been issued pursuant to a government-operated automobile insurance system, the Contractor shall provide the Owner with confirmation of automobile insurance coverage for all automobiles registered in the name of the Contractor.

**GC23.3 Aircraft and Watercraft Liability Insurance:**

Aircraft and watercraft liability insurance with respect to owned or non-owned aircraft and watercraft if used directly or indirectly in the performance of the Work, including use of additional premises, shall be subject to limits of not less than \$2,000,000 inclusive per occurrence for bodily injury, death, and damage to property including loss of use thereof and limits of not less than \$2,000,000 for aircraft passenger hazard. Such insurance shall be in a form acceptable to the Owner. The policies shall be endorsed to provide the Owner with not less than 15 days notice in writing in advance of cancellation, change, or amendment restricting coverage.

**GC23.4 Property and Boiler and Machinery Insurance:**

**GC23.4.1** "All risks" property insurance shall be in the joint names of the Contractor, the Owner and all Subcontractors, insuring not less than the sum of the amount of the Contract Price and the full value, of Products that are specified to be provided by the Owner for incorporation into the Work, or as stated in the Supplementary Conditions, with a deductible not exceeding \$2,500. The coverage shall be maintained continuously until 5 Working Days after the date of the final certificate for payment.

**GC23.4.2** Boiler and machinery insurance shall be in the joint names of the Contractor, the Owner, for not less than the replacement value of the boilers, pressure vessels, and other insurable objects forming part of the Work. The insurance provided shall not be less than the insurance provided by the "Comprehensive Boiler and Machinery Form" and shall be maintained continuously from commencement of use or operation of the property insured and until 5 Working Days after the date of the final certificate for payment.

**GC23.4.3** The policies shall allow for partial or total use or occupancy of the Work. If because of such use or occupancy the Contractor is unable to provide coverage, the Contractor shall notify the Owner in writing. Prior to such use or occupancy the Owner shall provide, maintain, and pay for all risk

The City of Morden

property and boiler insurance insuring the full value of the Work, as in sub-paragraphs (1) and (2), including coverage for such use or occupancy and shall provide the Contractor with proof of such insurance. The Contractor shall refund to the Owner the unearned premiums applicable to the Contractor's policies upon termination of coverage.

- GC23.4.4 The policies shall provide that, in the case of a loss or damage, payment shall be made to the Owner and the Contractor as their respective interests may appear. The Contractor shall act on behalf of the Owner for the purpose of adjusting the amount of such loss or damage payment with the insurers. When the extent of the loss or damage is determined, the Contractor shall proceed to restore the Work. Loss or damage shall not affect the rights and obligations of either party under the Contract except that the Contractor shall be entitled to such reasonable extension of Contract Time relative to the extent of the loss or damage as the Consultant may recommend in consultation with the Contractor.
- GC23.5 **Contractors' Equipment Insurance:**  
"All risks" contractors' equipment insurance covering Construction Equipment used by the Contractor for the performance of the Work, including boiler insurance on temporary boilers and pressure vessels, shall be in a form acceptable to the Owner and shall not allow subrogation claims by the insurer against the Owner. The policies shall be endorsed to provide the Owner with not less than 15 days notice in writing in advance of cancellation, change, or amendment restricting coverage. Subject to satisfactory proof of financial capability by the Contractor for self-insurance, the Owner agrees to waive the equipment insurance requirement.
- GC23.6 The Contractor shall be responsible for deductible amounts under the policies except where such amounts may be excluded from the Contractor's responsibility by the terms of C10 – Risk And Responsibility.
- GC23.7 Where the full insurable value of the Work is substantially less than the Contract Price, the Owner may reduce the amount of insurance required or waive the course of construction insurance requirement.
- GC23.8 All required insurance policies shall be with insurers licensed to underwrite insurance in the jurisdiction of the Place of the Work.

#### ***CONTRACT SECURITY***

- GC23.9 The Contractor shall, prior to commencement of the Work or within the specified time, provide to the Owner any contract security specified in the Contract Documents.
- GC23.10 If the Contract Documents require surety bonds to be provided, such bonds shall be issued by a duly licensed surety company authorized to transact the business of suretyship in the province or territory of the Place of the Work and shall be maintained in good standing until the fulfillment of the Contract. The form of such bonds shall be in accordance with the latest edition of the CCDC approved bond forms.

#### **GC 24 SCHEDULE OF WORK**

- GC24.1 The Contractor shall, prior to commencement of the Work, prepare and submit for the Engineer's approval, a Schedule of Work listing the order in which the Contractor proposes to carry on the Work, including the dates at which major or critical portions of the Work will commence and be completed, and confirming the construction start date and the completion date, the latter date being no later than the date specified in the Agreement for Final Completion of the Work. Once accepted by the Engineer, the Schedule of Work shall not be changed by the Contractor without the Engineer's approval. The Contractor shall be responsible for ensuring that all Work is carried out in accordance with and within the time limits set out in the Schedule of Work.
- GC24.2 If the progress of the Work falls behind the most recent approved Schedule of Work or is delayed for any reason other than one for which an extension of Contract Time is provided for under GC18 Time, the Contractor shall, at his sole cost work such additional time, including weekends and holidays, employ additional workers, or both as may be required to bring the work back on schedule.

The City of Morden

## **GC25 DELAYS**

- GC25.1 If the Contractor is delayed in the performance of the Work by:
- .1 a stop work order issued by a court or other public authority having jurisdiction and providing that such order was not issued as the result of an act or fault of the Contractor or anyone employed or engaged by him directly or indirectly;
  - .2 labour disputes, legitimate or legal strikes, lock-outs (including lock-outs decreed by a recognized contractors' association for its members of which the Contractor is a member);
  - .3 acts of God;
  - .4 unavoidable casualties;
  - .5 any other cause that is totally beyond his control, fault or negligence; or
  - .6 any other cause within the Contractor's control that the Engineer has determined is justified;
  - .7 any unduly prolonged delay upon the part of the City;
- then the Contract Time will be extended for a period of time equal to the time lost due to such delay.
- GC25.2 No extension of Contract Time or claim for costs due to delay will be granted by the Engineer unless a written notice, clearly stating the cause of delay and the length of extension requested, is received by the Engineer from the Contractor within seven (7) calendar days of the date on which the cause of the delay arose. In the case of a continuing cause of delay, only one notice shall be necessary. Failure to provide such notice shall constitute a waiver by the Contractor of any claim. The Engineer may require that any request for an extension of Contract Time be accompanied by a written consent of the Surety whose bonds form part of the Contract Documents.

## **GC26 LIQUIDATED DAMAGES**

Subject to the extensions of Contract Time as provided for herein, if the Contractor fails to achieve Final Completion of the Work in accordance with the Contract Documents and to the satisfaction of the City by the day fixed in the Agreement for Final Completion of the Work, the Contractor shall pay the City the sum stipulated in the Agreement as liquidated damages (and not as penalty) for each and every calendar day following that day fixed for Final Completion of the Work and ending on the day immediately preceding the date of the Certificate of Final Completion of the Work

## **GC27 NOTICES**

- GC27.1 All notices, requests, nominations, consents, approvals, statements, authorizations, documents or other communications required or permitted to be given under the Contract shall be in writing and shall be delivered by hand, by facsimile transmission (fax) or by mail.
- GC27.2 All notices, requests, nominations, consents, approvals, statements, authorizations, documents or other communications shall be delivered to the applicable addresses set out in the Supplemental Conditions.
- GC27.2.1 Either party may, by giving notice, designate another address or addresses at which it will accept delivery of notices, requests, nominations, consents, approvals, statements, authorizations, documents or other communications.
- GC27.2.2 Delivery to the Contractor's designated supervisor at the Site shall constitute delivery to the Contractor.
- GC27.3 Any notices, requests, nominations, consents, approvals, statements, authorizations, documents or other communications given as provided herein shall:
- (a) if delivered by hand, be deemed to have been received on the day of receipt;
  - (b) if delivered by facsimile transmission, be deemed to have been received on the day of transmission, if a Business Day, or if not a Business Day, on the Business Day next following the day of transmission; and
  - (c) if delivered by mail, be deemed to have been received on the second Business Day on which mail is delivered by Canada Post following the date of mailing.